

# 700 Series

Rotary Positive Displacement Flow Meter



The Standard of Measurement™



[www.TCSmeters.com](http://www.TCSmeters.com)

## Design Principle

The TCS 700 series rotary flow meter has a simple and efficient meter design consisting of a housing and three rotors that rotate in unison within the measuring chamber. The absence of wear, from no metal-to-metal contact within the chamber, eliminates any deterioration in accuracy and provides a long service life. The rotors are supported by bearings inserted into two bearing plates, where at the end of each rotor shaft is a timing gear. The timed rotation between each rotor is then transferred through the calibration adjuster to the register, giving a consistent and superior measurement of accuracy.

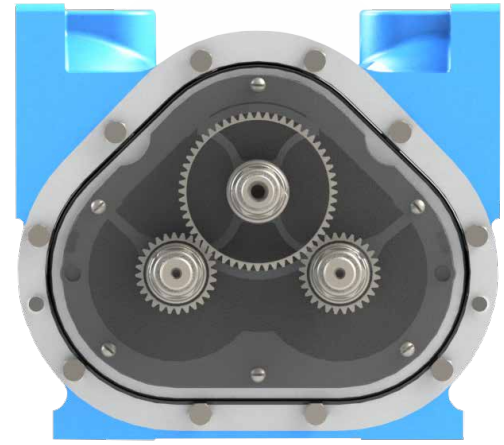

## Performance Features

The TCS 700 rotary flow meter combines excellent accuracy with low pressure drop. The TCS 700 rotary flow meter has a compact size and lightweight design that offers minimal maintenance and long service life. This meter is built with advanced materials of construction for a broad range of measurement applications and is accompanied by a full selection of accessories and electronic registration.

<b>FLOW:</b>	Capable of up to 1,000 GPM (3,785 LPM); Bi-directional flow
<b>LINEAR ACCURACY:</b>	Capable of $\pm 0.15\%$ over the full flow range
<b>REPEATABILITY:</b>	Capable of 0.02% (constant operation conditions with 700SP meters & mechanical registration, using 1 CPS test fluid)
<b>VISCOSITY:</b>	Will accurately measure liquids up to 1,500,000 SSU (325,000 CPS)
<b>REGULATORY:</b>	Meets a wide range of global weights and measures requirements. (Contact factory for information on specific approvals.)

## Meter Operating Specifications

Meter	Type(s) Available	Flange Connection(s)*	Max. Capacity	Working Pressure**	Working Temperature***
700-15	SP, SPA, IP & IC	1 1/2" NPT Flange; 1" & 2" Options	60 GPM (227 LPM)	150 PSI (10.5 BAR)	-40°F to 160°F (-40°C to 71°C)
700-20	SP, SPA, SPD, IP, IC, AF, SS, SSD & LP	2" NPT Flange; 1 1/2" Option	100 GPM (380 LPM)	150 PSI (10.5 BAR)	-40°F to 160°F (-40°C to 71°C)
700-25	SPA & SPD	2" NPT Flange	150 GPM (567 LPM)	150 PSI (10.5 BAR)	-40°F to 160°F (-40°C to 71°C)
700-30	SP, SPA, SPD, IP, IC & AF	3" NPT Flange; 2" Option	200 GPM (760 LPM)	150 PSI (10.5 BAR)	-40°F to 160°F (-40°C to 71°C)
700-35	SPA & SPD	3" NPT Flange	300 GPM (1,135 LPM)	150 PSI (10.5 BAR)	-40°F to 160°F (-40°C to 71°C)
700-40	SP, SPA, SPD, IP, IC & AF	4" NPT Flange; 3" Option	500 GPM (1,893 LPM)	150 PSI (10.5 BAR)	-40°F to 160°F (-40°C to 71°C)
700-45	SPA & SPD	4" NPT Flange	600 GPM (2,271 LPM)	150 PSI (10.5 BAR)	-40°F to 160°F (-40°C to 71°C)
700-60	SPA	6" ANSI Flange	800 GPM (3,040 LPM)	150 PSI (10.5 BAR)	-40°F to 160°F (-40°C to 71°C)
700-65	SPA	6" ANSI Flange	1000 GPM (3,800 LPM)	150 PSI (10.5 BAR)	-40°F to 160°F (-40°C to 71°C)

\* Flanged NPT is standard; BSPT, Slip Weld, ANSI & others are available upon request

\*\* Higher working pressures are available. (Consult factory for more information.)

\*\*\* Higher working temperatures can be achieved at reduced pressures. (Consult factory for more information.)

# Meter Types

<b>SP</b>	<b>Standard Petroleum</b>	For metering refined petroleum products such as Gasoline, Fuel Oils, Diesel, Bio-Diesel, Kerosene, Vegetable Oils, Motor Oils, Naptha, Ethylene Glycol, etc.
<b>SPA</b>	<b>Standard Petroleum (Aviation)</b>	For metering refined petroleum products such as Aviation Gasoline, Jet Fuels, Ethanol, Gasoline, Fuel Oils, Diesel, Bio-Diesel, Kerosene, Vegetable Oils, Motor Oils, Naptha, Ethylene Glycol, etc.
<b>SPD</b>	<b>Standard Petroleum (Ductile Iron)</b>	For metering refined petroleum products such as Ethanol, Methanol, Gasoline, Fuel Oils, Diesel, Bio-Diesel, Kerosene, Aviation Gasoline, Vegetable Oils, Motor Oils, Naptha, Ethylene Glycol, etc.
<b>AF</b>	<b>All-Ferrous</b>	For metering Pesticides, Fertilizers, Food Processing Liquids, Industrial Chemicals, Solvents, Paints, Inks, Alcohols and many other liquids; such as Liquid Sugars, Liquid Feeds, MEK, Ethanol, Corn Syrup, Soy Bean Oil, Shortenings, Latex Products, Adhesives, Naptha, etc.
<b>IP</b>	<b>Industrial Products</b>	For Food Processing, Chemicals, General Solvents and many other liquids such as Corn Syrup, Soy Bean Oil, Liquid Sugars, Shortenings, Latex Products, Adhesives, etc.
<b>IC</b>	<b>Industrial Chemicals</b>	For metering Alcohols, Chemicals, Solvents, Water and many other Non-Lubricating Liquids such as Acetones, Ethanol, Naphta, Xylene, MEK, Toluene, Resins, etc.
<b>SS</b>	<b>Stainless Steel</b>	For metering the same products as the SP, SPA, SPD, IP, IC and AF meter types, but includes special handling liquids; such as Acids, Anti-Icing Fluids, Vinegar, Fruit Juices, Corn Syrup, Micro-Nutrients, etc.
<b>SSD</b>	<b>Stainless Steel (DEF)</b>	For metering Diesel Exhaust Fluid (DEF), AdBlue, ARLA and AUS32
<b>LP</b>	<b>Liquefied Petroleum</b>	For metering Liquefied Petroleum Gas (LPG), NH3

# Meter Materials of Construction

Description	SP	SPA	SPD	AF	IP	IC	SS	SSD	LP
<b>Housing</b>	Hardcoat Anodized Aluminum	Hardcoat Anodized Aluminum	Ductile Iron	Ductile Iron	Hardcoat Anodized Aluminum	Hardcoat Anodized Aluminum	Stainless Steel	Stainless Steel	Hardcoat Anodized Aluminum
<b>Rotors</b>	Hardcoat Anodized Aluminum	Hardcoat Anodized Aluminum	Ni-Resist	Ni-Resist	Hardcoat Anodized Aluminum	Hardcoat Anodized Aluminum	Stainless Steel	Stainless Steel	Hardcoat Anodized Aluminum
<b>Rotor Journals</b>	Plated Stainless Steel	Plated Stainless Steel	Plated Stainless Steel	Plated Stainless Steel	Plated Stainless Steel	Plated Stainless Steel	Plated Stainless Steel	Plated Stainless Steel	Plated Stainless Steel
<b>Bearing Plates</b>	Ni-Resist	Ni-Resist	Ni-Resist	Ni-Resist	Ni-Resist	Ni-Resist	Stainless Steel	Ryton	Ni-Resist
<b>Bearing Sleeves</b>	Ni-Resist	Carbon Graphite	Carbon Graphite	Carbon Graphite	Ni-Resist	Carbon Graphite	Carbon Graphite	Ryton	Ni-Resist
<b>Timing Gears</b>	Stainless Steel	Stainless Steel	Stainless Steel	Stainless Steel	Stainless Steel	Stainless Steel	Stainless Steel	Stainless Steel	Stainless Steel
<b>Packing Seal</b>	FKM	FKM	Simriz®	Simriz®	Simriz®	Simriz®	Simriz®	EPDM	Buna
<b>Body O-ring</b>	FKM	FKM	FKM	PTFE	PTFE	PTFE	PTFE	EPDM	Buna

\*Simriz is a registered trademark of Freudenberg-NOK

Check out our other solutions online at  
[www.TCSmeters.com!](http://www.TCSmeters.com)

## Meter Accessories



### Electronic Registration

TCS 3000 electronic register is a fully integrated flow computer that will control all delivery operations. The modular design and open software architecture provide you with a tailored system that is expandable for future needs.



### TCS HUB Delivery Software

TCS HUB is a SQL-based software designed to capture truck delivery information wirelessly to be electronically collected at locations and/or the home office. The TCS HUB software supports both line of sight wireless modems and/or cellular modems for real-time delivery tracking.



### Pulse Transmission

The DMP pulse transmitters provide accurate signals for remote indication, totalizers and data monitoring systems by transferring the mechanical rotation of the flow meter into an electronic pulse. This pulse can be used by the TCS 3000 or a flow computer of your choice.



### Air/Vapor Elimination

Mechanical and electronic air eliminators are devices designed to extract free or accumulated volumes of air or vapor from a liquid dispensing system to achieve accurate measurement results.



### Control Valves

Mechanical, pneumatic and electronic actuated piston and diaphragm control valves designed to meet the variety of needs in the fluid process industry. Such valves include preset flow control valves, air differential control valves, pressure relief and safety valves.



### Mechanical Registration

Mechanical 5 wheel register V/R 7887 or 6 wheel register V/R 7886 with optional preset, ticket printer, swivel, micro switch and register mounted pulser.



### Miscellaneous

Miscellaneous product accessories were developed to increase functionality of your metering solution. Such items as flow indication, RTD temperature probes, clutch assemblies, insulation jackets, protective covers and various flange connections.

### Authorized Distributor



The Standard of Measurement™

2515 Charleston Place  
Fort Wayne, Indiana 46808  
United States of America

[www.TCSmeters.com](http://www.TCSmeters.com)  
[sales@tcsmeters.com](mailto:sales@tcsmeters.com)  
(800) 348-4753  
(260) 484-0382



Made in U.S.A.

© 2016 Total Control Systems  
TCS 910000.002



The Standard of Measurement

# 700-20/25 Rotary Meter

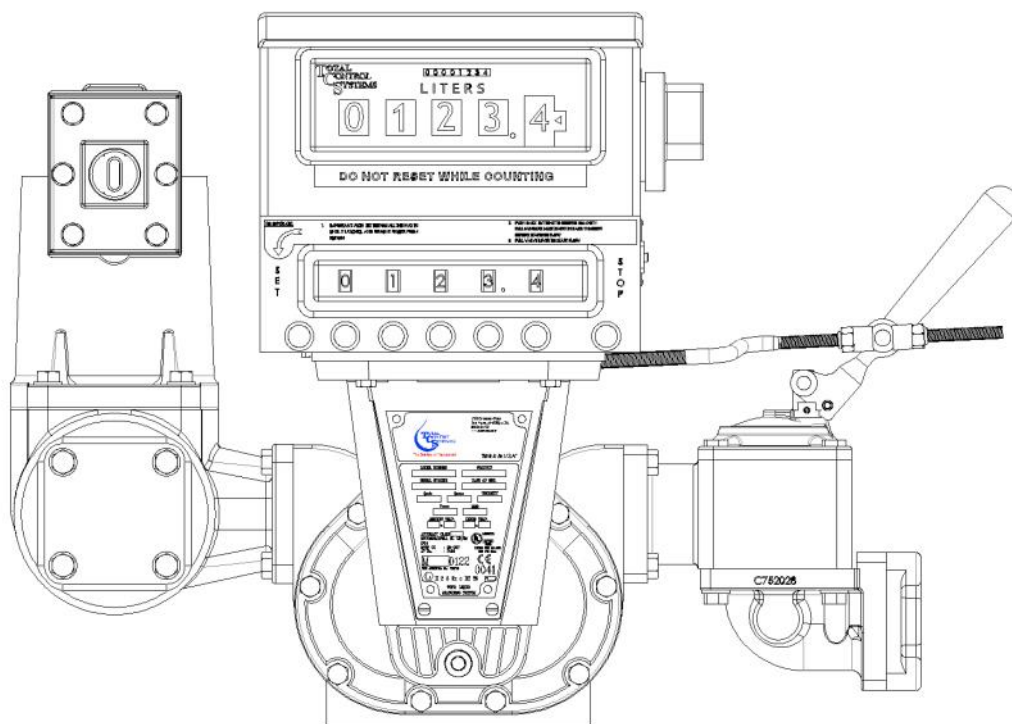

## Installation, Operation & Maintenance Manual

## Table of Contents

Safety Warning Symbols	2	Strainer Assembly	26
Receipt & Inspection	3	Strainer Assembly (Continued)	27
Notice	3	Hydraulic Preset Valve Assembly	28
Meter Overview	4	Hydraulic Preset Valve Assembly (Continued)	29
Meter Specifications	5	Air Check Valve Assembly	30
Meter Types	5	Torque Specifications	31
Material of Construction	6	Drive Components	32
System Recommendations	6	Disassembly of Meter	33
System Recommendations (Continued)	7	Disassembly of Meter (Continued)	34
System Recommendations (Continued)	8	Disassembly of Meter (Continued)	35
Above Ground Storage System	9	Inspection of Parts	36
Mobile Fueling System	10	Assembly of Meter	37
Start Up Recommendations	11	Assembly of Meter (Continued)	38
Start Up Recommendations (Continued)	12	Assembly of Meter (Continued)	39
Direction of Flow	12	Assembly of Meter (Continued)	40
Meter Calibration	13	Assembly of Strainer	41
Meter Calibration (Continued)	14	Assembly of Air Eliminator	42
Meter Calibration (Continued)	15	Disassembly of Hydraulic Preset Valve	43
Calibration Adjustment	15	Assembly of Hydraulic Preset Valve	44
Split Compartment Testing	16	Assembly of Air Check Valve	45
Split Compartment Testing (Continued)	17	Meter Trouble Shooting	46
Split Compartment Testing (Continued)	18	Air Eliminator Trouble Shooting	47
Maintenance	19	Hydraulic Preset Valve Trouble Shooting	48
Maintenance (Continued)	20	Air Check Valve Trouble Shooting	48
Storage Instructions	20	Material Safety Data Sheet	49
Dimensions	21	MSDS (Continued)	50
Meter Assembly	22	MSDS (Continued)	51
Meter Assembly (Continued)	23	MSDS (Continued)	52
Air Eliminator Assembly	24	Notes	53
Air Eliminator Assembly (Continued)	25	Notes	54
		Warranty	55

## Warning Symbols



### CAUTION

Follow the warning instructions within the following information to avoid equipment failure, personal injury or death.



### TURN POWER OFF

Before performing any maintenance, be sure to turn system power off to avoid any potential electric spark



### FLAMMABLE

Flammable liquids and their vapors may cause a fire or explosion if ignited.



### EYE PROTECTION

Pressurized systems may cause hazardous leaks and spray that may be dangerous for your eyes. Always wear eye protection around pressurized systems and its hazardous liquids.



### INJURY

Wear gloves for protection from hazardous liquids that may cause irritation or burns.



### READ

Read and understand all related manuals thoroughly. The Engineering and OIM manuals will provide the knowledge for all systems, maintenance and operation procedures. If you have any questions, please consult the factory.

## Receipt & Inspection

Upon receipt of meter shipment, be sure to inspect the packaging and the flow meter assembly for any damage before signing the receipt of the shipment. Notify the delivery company about possible damage and refuse receipt of the shipment.

Meters are individually boxed and are protected with packing material. Each package is identified with the flow meter assembly part number, description, direction of flow and serial number. Verify the meter model is the correct model, size, and configuration as ordered. Contact your distributor if there is any discrepancy or question.

Meter assemblies should be handled with appropriate methods for the awkwardness of size and weight involved. Appropriate clothing and shoes need to be utilized. Transport the meter package to the installation site with appropriate transportation methods, careful not to damage the flow meter.

Be careful of any loose or protruding staples from the packaging, as they can be very sharp and may potentially cause injury.

If foam has been used to protect meter, carefully remove top foam layer before attempting to remove meter assembly from box. Foam packaging maybe formed around the meter assembly making it difficult to remove. If meter is bolted to a wood pallet remove bolts while being careful not to let the meter tip over when the support has been removed. Do not lift the meter assembly by flex hoses, thermowells, wires, pulsers, or put objects through meter. Removing meter assembly from packaging without regard to these warnings may cause serious injury.

The wooden pallets and bases meet the ISPM 15; Guidelines for Regulating Wood Packaging Material in International Trade through the Timber Products Inspection Company (TP #2134).

Every effort has been made to remove the test fluid before shipment. All TCS flow meters are plugged and enclosed in a plastic bag. The test fluid Material Safety Data Sheet (MSDS) can be reviewed on page 50. Appropriate precautions should be taken regarding any personal, environmental and material compatibility with the end use system.

## Notice

Total Control Systems (TCS) shall not be liable for technical or editorial errors in this manual or omissions from this manual. TCS makes no warranties, express or implied, including the implied warranties of merchantability and fitness for a particular purpose with respect to this manual and, in no event, shall TCS be liable for special or consequential damages including, but not limited to, loss of production, loss of profits, etc.

The contents of this publication are presented for informational purposes only, and while every effort has been made to ensure their accuracy, they are not to be construed as warranties or guarantees, expressed or implied, regarding the products or services described herein or their use or applicability. We reserve the right to modify or improve the designs or specifications of such products at any time.

TCS does not assume responsibility for the selection, use or maintenance of any product. Responsibility for proper selection, use and maintenance of any TCS product remains solely with the purchaser and end-user.

***All rights reserved. No part of this work may be reproduced or copied in any form or by any means – graphic, electronic or mechanical – without first receiving the written permission of Total Control Systems, Fort Wayne, Indiana USA.***

## Meter Overview

The TCS Model 700 series flow meter is a simple and efficient design. The meter consists of a single fluid chamber that contains a single blocking rotor and two displacement rotors whose rotation is synchronized with mating gears. As the fluid enters the fluid chamber, the blocking rotor is forced to rotate. The displacement rotors, also rotating in conjunction with the blocking rotor help direct the fluid flow through the chamber and to the outlet. The linear flow of the fluid is thus translated into rotary motion in the meter. The output of the meter is picked up from the rotation of the blocking rotor and transmitted to a register or pulse transmitter.

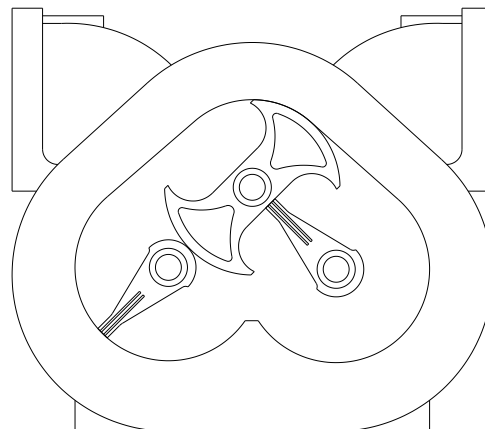

The rotors in the meter are designed to operate at close tolerances to one another and the wall of the fluid chamber. There are slight clearances between the rotors and the chamber wall. Because of this, it is important that the meter be properly applied for the flow rate and operating pressure of the system.

Because the fluid flowing through the meter is redirected only slightly from its natural flow, there is very little pressure drop across the meter, unlike other meters that use multiple measuring chambers.

The meter design uses high performance materials for the rotor bearings and journals. Since there is no contact between the rotors and the fluid chamber wall, these critical components have a long life expectancy.

Calibration of the meter involves adjusting the rotation of the output shaft relative to the rotation of the internal rotors of the meter. This is accomplished by changing the settings on an adjuster device. Calibration of the meter is discussed in detail in the section Meter Calibration.

### FLOW ILLUSTRATION

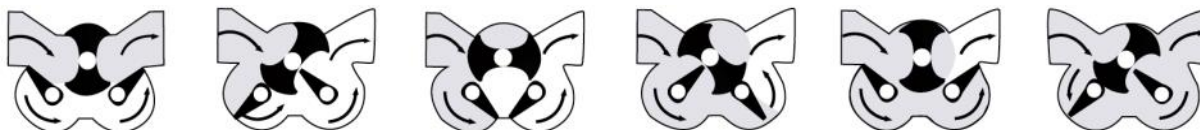



## Meter Specifications

Flange Connection:	2” NPT Flange Connection, 1-1/2” NPT Flange. Optional BSPT, Slip Weld or ANSI flanges available upon request.
Flow Rate:	700-20 up to 100 GPM (380 LPM) 700-25 up to 150 GPM (567 LPM); only for fluids under 225 SSU
Maximum Pressure:	150 PSI (10.5 BAR)
Working Temperature:	-20 F to 160 F (-28.9 C to 71 C) -40 F to 160 F (-40 C to 71 C) with low temperature seal kit

## Meter Types

### **SP - Standard Petroleum**

For metering refined petroleum products such as Gasoline, Fuel Oils, Diesel, Bio-Diesel, Kerosene, Vegetable Oils, Motor Oils, Naptha, Ethylene Glycol (Antifreeze), etc.

### **SPA - Standard Petroleum (Aviation)**

For metering refined petroleum products such as Aviation Gasoline, Jet Fuels, Ethanol, Gasoline, Fuel Oils, Diesel, Bio-Diesel, Kerosene, Vegetable Oils, Motor Oils, Naptha, Ethylene Glycol, etc.

### **SPD - Standard Petroleum (Ductile Iron)**

For metering refined petroleum products such as Ethanol, Methanol, Gasoline, Fuel Oils, Diesel, Bio-Diesel, Kerosene, Aviation Gasoline, Vegetable Oils, Motor Oils, Naptha, Ethylene Glycol, etc.

### **AF - All-Ferrous**

For metering Pesticides, Fertilizers, Food Processing Liquids, Industrial Chemicals, Solvents, Paints, Inks, Alcohols and many other liquids such as Liquid Sugars, Liquid Feeds, MEK, Ethanol, Corn Syrup, Soy Bean Oil, Shortenings, Latex Products, Adhesives, Naptha, etc.

### **IP - Industrial Products**

For Food Processing, Chemicals, General Solvents and many other liquids such as Corn Syrup, Soy Bean Oil, Liquid Sugars, Shortenings, Latex Products, Adhesives, etc.

### **IC - Industrial Products (Carbon Bearings)**

For metering Alcohols, Chemicals, Solvents, Water and many other non-lubricating liquids, such as Acetones, Ethanol, Naptha, Xylene, MEK, Toluene, Resins, etc.

### **SS - Stainless Steel**

For metering the same liquids as the SP, SPA, SPD, IP, IC and AF flow meters, but also food processing and special handling fluids such as Nitric, Phosphorus and Glacial Acetic Acids, Anti-Icing Fluids, Vinegar, Fruit Juices, etc.

### **SSD - Stainless Steel (DEF)**

For metering Diesel Exhaust Fluid (DEF), AdBlue, ARLA and AUS32.

## Material of Construction

Description	SP	SPA	SPD	IP	IC	AF	SS	SSD
Housing	Hardcoat Anodized Aluminum	Hardcoat Anodized Aluminum	Ductile Iron	Hardcoat Anodized Aluminum	Hardcoat Anodized Aluminum	Ductile Iron	Stainless Steel	Stainless Steel
Rotors	Hardcoat Anodized Aluminum	Hardcoat Anodized Aluminum	Ni-Resist	Hardcoat Anodized Aluminum	Hardcoat Anodized Aluminum	Ni-Resist	Stainless Steel	Stainless Steel
Rotor Journals	Plated SS	Plated SS	Plated SS	Plated SS	Plated SS	Plated SS	Plated SS	Plated SS
Bearing Plates	Ni-Resist	Ni-Resist	Ni-Resist	Ni-Resist	Ni-Resist	Ni-Resist	Stainless Steel	Ryton
Bearing Sleeves	Ni-Resist	Carbon Graphite	Carbon Graphite	Ni-Resist	Carbon Graphite	Carbon Graphite	Carbon Graphite	Ryton
Timing Gears	Stainless Steel	Stainless Steel	Stainless Steel	Stainless Steel	Stainless Steel	Stainless Steel	Stainless Steel	Stainless Steel
Packing Seal	FKM	FKM	Simriz®	Simriz®	Simriz®	Simriz®	Simriz®	EPDM
Body O-rings	FKM	FKM	PTFE	PTFE	PTFE	PTFE	PTFE	EPDM

Simriz® is a registered trademark of Freudenberg-NOK.

## System Recommendations



### Meter Selection

The flow meter must be carefully chosen from the Meter Selection factors in the Engineering Manual. The meter must be selected based on the operating system and product characteristics. System variables include flow rate, temperature and pressure. Product characteristics include the material compatibility, lubricity, viscosity, presence of suspensions, pH, and whether the product can congeal, crystallize or leave a dry film. Failure to select the correct flow meter may result in system failure or serious injury.

### Air Elimination

In any system where the supply tank may be completely drained or multiple products manifold into one metering system, the possibility of air being introduced into the fluid piping increases. The solution is to utilize an air or vapor eliminator in the system, located upstream of the flow meter. The purpose of this device is to vent the air or vapor from the system before it can be measured by the meter. Air or vapor elimination is required for all weights and measures regulatory approvals in custody transfer applications.

## System Recommendations (Continued)



### Control Valves

Safety and isolation valves should be used throughout the metering system. In any pumping system where there is one (1) pump and multiple flow meters, a digital or hydro-mechanical Rate-of-Flow control valve must be used at each flow meter to prevent over-speeding of the flow meters.

### Best Plumbing Configuration

- 1) The flow meter must be securely mounted to a riser or foundation.
- 2) The inlet and outlet piping must be securely supported, in such a manner so as to avoid pipe stress on the flow meter.
- 3) The system should be designed to keep the flow meter full of liquid at all times.
- 4) System piping should have full 3" pipe diameter throughout the metering system to allow for minimal pressure loss.
- 5) The pipe should be laid out as straight as possible to reduce pressure loss from flow restriction.
- 6) The meter and piping must be installed in such a way so as to avoid accidental draining of the meter. The inlet and outlet of the meter should be lower than the associated system plumbing. This is known as the sump position.
- 7) It is not necessary for the air eliminator to be installed directly adjacent to the meter. It can be installed upstream from the meter. For effective operation of the air eliminator, it should be mounted between the meter and any valves, tees or any other potential places where air may enter the system.
- 8) The metering system should include a means for calibration.

### Protection From Debris

On new installations, care must be taken to protect the meter from damage during start-up. It is recommended that a strainer be installed in the system upstream from the meter. The meter could be subject to damage from the passage through of dirt, sand, welding slag or spatter, thread cuttings, rust, etc. A spool can be fabricated and installed in place of the meter until the system is flushed. A spool is a flanged length of pipe equal in length to the meter and any accessories attached to the meter such as an air eliminator or control valve. Another method is to temporarily bypass the plumbing containing the meter until the system is flushed. This will also protect the meter from debris. Once the system has run "clean" for a period of time the meter may be reinstalled or protective means removed.

### Thermal Expansion

Most liquids will expand and contract with temperature. In any system where there is a chance for liquid to be captured between closed valves without relief, thermal expansion will likely occur. This can create dangerously high pressures within the system. When product is trapped within the system, the pressure will increase as temperature increases.

Care should be taken in designing the system in which thermal expansion may occur by implementing Pressure Relief Valves or Thermal Expansion Joints in the system design.

## System Recommendations (Continued)



### Thermal Shock

The metal parts within the flow meter will expand or contract with variations in the system operating temperature. For any systems where sudden or immediate temperature increases of 68 F (20 C) degrees or more are possible, the meter will require clearance rotors. The extra clearance will be necessary to eliminate the effects of immediate expansion of the rotors vs. the meter body, caused by thermal shock.

### Hydraulic Shock (Water Hammer)

Hydraulic shock is a rise in pressure, which happens when an operating system undergoes an immediate change in flow direction. This is most often the result of a rapid valve closure while the system is operating at a high flow rate. Hydraulic shock can damage any system component. Particularly susceptible are internal components of the meter, valves, and pump. System design and improper operating procedures will contribute to the seriousness of this problem. In order to eliminate hydraulic shock, the valve closure rate must be slowed. The use of 2-stage preset control valves or surge suppressing bladders or risers will help reduce or eliminate this problem.

### Products that Dry/Congea/Crystallize

There are many liquids that crystallize, harden and/or solidify on contact with air or with an increase in temperature. A proper system design and a good understanding of the product being measured will help to avoid the possibility of air entering into the system and the product and effective operation of the meter being affected.

### Calibration

The meter shall be tested and calibrated with the product it is intended to measure when installed. Total Control Systems shall not be responsible for loss of product or any damages resulting from the end user's failure to test this meter to insure proper calibration. Every 700 series meter is tested at the factory to prove that the meter can be calibrated in your system. It is the owner's responsibility to report this device to the local Weights and Measures officials for their inspection before the meter is put to use.

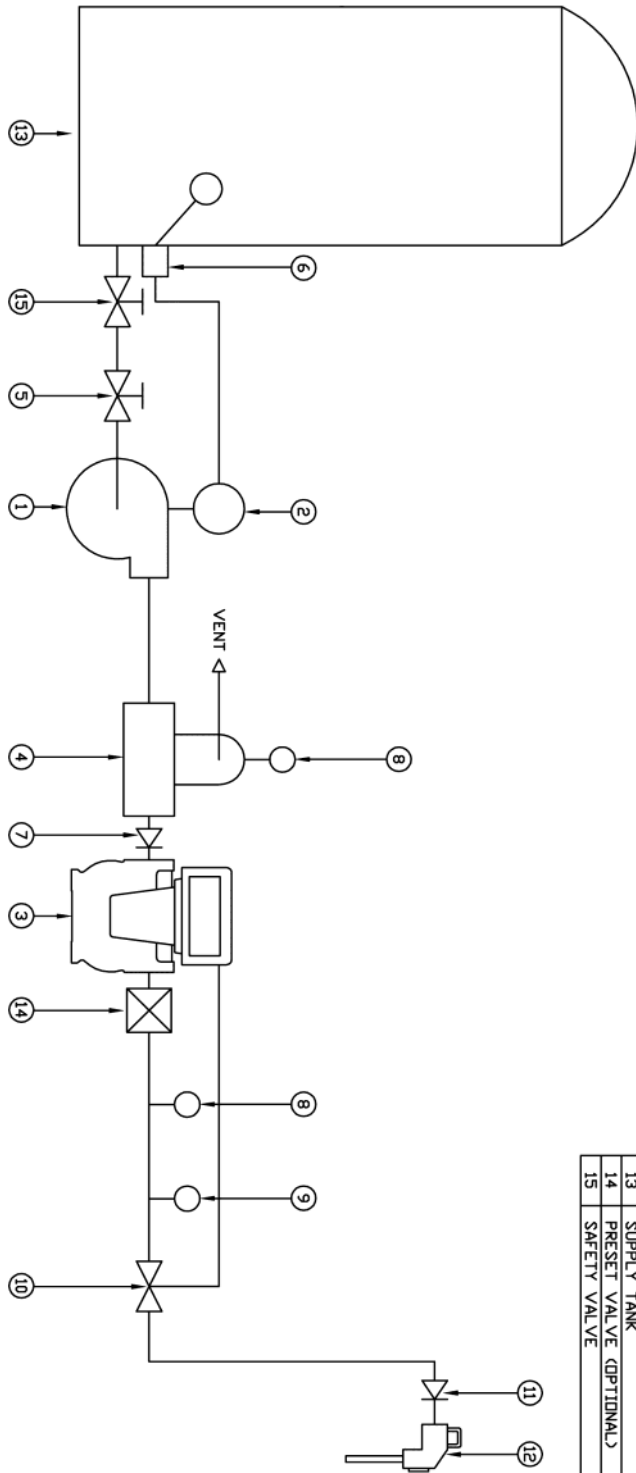

**PARTS LIST**

ITEM	DESCRIPTION
1	PUMP
2	PUMP MOTOR
3	FLOW METER W/ REGISTER
4	STRAINER/VAPOR ELIMINATOR
5	ISOLATION VALVE
6	LIQUID LEVEL CONTROL DEVICE (OPTIONAL)
7	CHECK VALVE
8	PRESSURE GAUGE (OPTIONAL)
9	TEMPERATURE GAUGE (OPTIONAL)
10	FLOW RATE CONTROL VALVE
11	CHECK VALVE
12	FILL NOZZLE
13	SUPPLY TANK
14	PRESET VALVE (OPTIONAL)
15	SAFETY VALVE

**CONFIDENTIAL**

THIS DRAWING AND THE INFORMATION CONTAINED HEREIN ARE CONFIDENTIAL AND PROPRIETARY TO MURRAY EQUIPMENT, INC. THE DRAWING MAY NOT BE COPIED OR DISCLOSED TO OTHERS WITHOUT EXPRESS WRITTEN PERMISSION OF MURRAY EQUIPMENT, INC.

**IRISH-FILLING LIQUID-MEASURING SYSTEM**

**FTB**

**TOTAL CONTROL SYSTEMS**  
A DIVISION OF  
MURRAY EQUIPMENT, INC.

DATE	08/16/06	DRAWING NUMBER	TCS00111
BY:	SEP	REV.	

**MURRAY EQUIPMENT, INC.**  
77 WEST AVENUE  
MURRAY, PA 15270

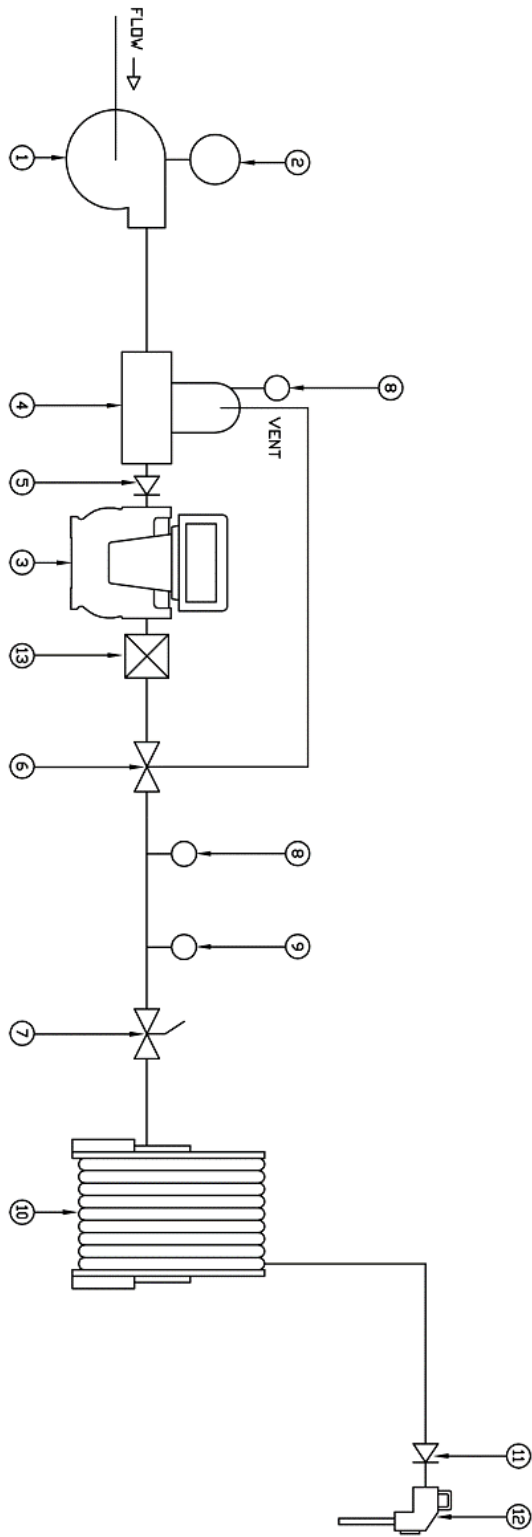

**PARTS LIST**

ITEM	DESCRIPTION
1	PUMP
2	PUMP MOTOR
3	FLOW METER W/ REGISTER
4	STRAINER/VAPOR ELIMINATOR
5	CHECK VALVE
6	AIR CHECK VALVE (OPTIONAL)
7	FLOW RATE CONTROL VALVE
8	PRESSURE GAUGE (OPTIONAL)
9	TEMPERATURE GAUGE (OPTIONAL)
10	HOSE REEL
11	CHECK VALVE
12	FILL NOZZLE
13	PRESET VALVE (OPTIONAL)

**CONFIDENTIAL**  
THIS DRAWING AND THE INFORMATION CONTAINED THEREIN ARE CONFIDENTIAL AND NOT TO BE DISCLOSED TO OTHERS WITHOUT EXPRESS WRITTEN PERMISSION OF MURRAY EQUIPMENT, INC.

**MURRAY EQUIPMENT, INC.**  
FOR  
TOTAL CONTROL SYSTEMS  
A DIVISION OF  
MURRAY EQUIPMENT, INC.

**MOBILE LIQUID-MEASURING SYSTEM**

DATE: 08/16/06  
DRAWING NUMBER: TCS00112

## Start up Recommendations



### ***!WARNING!***

Test equipment should be grounded to prevent a possible spark. Test area should have no ignition source. Operators should wear personal protection and prevent any product exposure and environmental issues.

Start-up instruction for new installations or after maintenance and repairs:

- 1) Only properly trained personal should design, install, or operate metering system.
- 2) Remove plastic threaded plugs placed in meter for shipping protection. They are not to be used in meter system because of the PVC plugs low rated pressure, compatibility, and sealing issues.
- 3) Place the meter in an area with ample workspace, secure from vibration, and pipe line stress. Mount and bolt down on to a fixed stand or platform. This prevents meter stress, which will cause leakage and metal fatigue.
- 4) Apply thread sealing compound and gasket materials that are compatible with product.
- 5) Do not weld to meter or meter accessories such as valves and air eliminators. This will weaken housings, cause O-ring and casting leaks and potentially distort the critical tolerances within the flow meter.
- 6) Always wear personal safety protection equipment such as goggles, steel toed shoes, gloves and full body clothing.
- 7) Be sure to install a pressure relief valve or expansion joint in the system to protect against thermal expansion.
- 8) Make sure all system components are properly secured and tightened.
- 9) All meter assembly bolts and connections are tight.
- 10) The air eliminator vapor release must be properly vented to atmospheric pressure and piped into a reservoir container or back to the supply tank.
- 11) Electrical connections are properly installed and start/stop switches are off and locked-out.
- 12) Ensure that there is flooded suction to the Pump and that fluid is available to system to prevent the starving or cavitation of the pump.
- 13) Flood the system slowly. **Start the system with all shut off valves in the closed position.** When a pump is turned on and a valve opened in a new, dry system, tremendous liquid and air pressure can build up in the piping and be forced through the meter. The high pressure and volume of air causes the meter to rotate more rapidly than normal. When the fluid product reaches the meter, there is an abrupt slowing of the meter rotor. This can cause damage to the register, rotor shafts, packing gear and/or blade, timing gears and other components.

***The recommended method of starting any system is to flood the piping gradually. This allows product to slowly force the air from the entire system.***

## Start-Up Recommendations (CONTINUED)



- 14) When operating the meter with accessories, valves should be opened slowly to avoid a pressure surge that can damage the meter or air eliminator. System pressures should be maintained below 70 PSI (4.9 BAR).
- 15) Custody transfer metering systems must be calibrated by a regulatory agency before product can be sold off the meter. Contact your local authorities for proper calibration.
- 16) Strainers should be cleaned frequently as part of a regular maintenance schedule. Doing so will ensure a clean system and long service life.

## Direction of Flow

The meter is set up at the factory for left to right flow. To change the meter for right to left flow, begin by removing the screws (#9 on the Meter Assembly Breakdown) and the adjuster cover plate (#7) on the front of the meter. Remove the screws (#1), the drive shaft retainer (#10), the drive shaft (#3), the e-ring (#4) and the face gear (#5). Reinstall the gear on the shaft with the gear teeth facing up. Snap the e-ring back into place to hold the gear in place. Reinstall the shaft, mating the face gear with the drive gear of the packing capsule assembly. Reinstall the screw and cover plate. The meter will now be set up for right to left flow. See Page 22 for a parts breakdown of entire meter assembly.

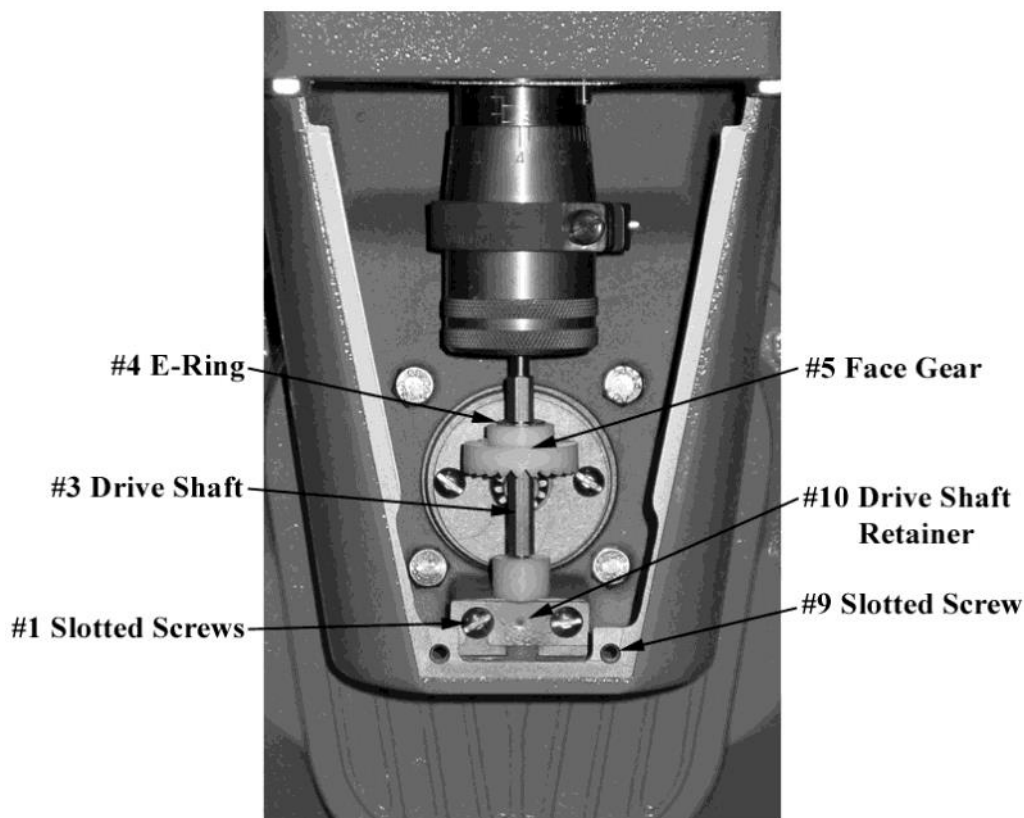



## Meter Calibration



The method of proving should be selected, and necessary provisions made, during the design stage of the installation. Of the most commonly used systems, portable provers have the advantage of more closely reproducing the conditions under which the product is normally delivered.

### Use an Accurate Prover

Scientifically designed provers are commercially available for proving meters, and no other kind should be used.

Scientifically designed test measures have proper drainage means built into them, a calibration gauge glass neck and protection against deformation (which would cause volume changes).

Scientifically designed provers are not merely truck compartments or drums. A “homemade” prover, whether a drum or a tank is not likely to be satisfactory, and may cause expensive errors due to inaccurate meter calibration.

Even scientifically designed provers should be checked periodically for accuracy. Weights and Measures officials have been very cooperative in giving assistance to checking privately owned volumetric provers.

### Recommended size of test measure

The prover capacity should be equal to at least one minute’s flow through the meter at its maximum rate.

### Setting the Prover

The prover should be set level, using the levels provided on the prover, or separate leveling means. This insures consistent results when moving the prover from meter to meter and provides the basis for accurate readings on the prover scale.

### Where to Test a Meter

The best place to test a meter is in its normal operating position, instead of a test stand. In this way, the correctness of the installation and of the operating conditions of the system will be verified by the test. Always test a meter with the same liquid it is to measure. Even slight differences in viscosity, temperature or system plumbing can have a significant effect on meter accuracy.

### Discharge Line from Meter

Where a portable prover is used, the liquid is generally discharged into the prover in the same manner as a normal delivery would be made (with a hose reel and nozzle, for example). Where a special delivery test connection is used, the discharge line must be arranged to drain to the same point on each test. The meter flow rate and start and stop must be controlled at the end of the discharge line.

### Wetting the Prover

Reset the meter register to zero, and fill the prover to the zero line or 100% marking of the scale. Disregard this meter reading. Drain the prover and reset the register. The reason for disregarding the first meter reading is that the prover must be wetted. The calibrated capacity of the prover has been determined by its manufacturer based its wet measure capacity. Once wetted, the prover will be wet for all the subsequent tests to be run.

Allow the prover to drain for a set amount of time before closing the dump valve. 30 seconds is a commonly used time interval. However, you must ensure that the prover is completely empty prior to closing the dump valve. This time interval must be the same for each test to ensure uniform results. If a considerable length of time is to elapse between tests (lunch break or phone call), the wetting operation can be eliminated by allowing the prover to remain full until the next test is to be run.

## Meter Calibration (Continued)



### Making the Tests

The setup is now ready for accuracy the test. Reset the register to zero, and run the required test quantity through the meter. Do not exceed the maximum recommended rate of flow for the meter. Maximum and minimum recommended rates of flow for various sizes and types of 700 series meters are marked on the flow meter's identification plate and in the maintenance manuals.

### Determining Test Results

Run the meter close to the mark on the indicator corresponding to the full prover capacity. Read the over or under delivery in cubic inches, gallons or percent on the calibrated plate on the neck of the prover. If the plate is calibrated in cubic inches, the percentage error can readily be computed on the following basis:

**One gallon is equal to 231 cu.in.**

Example: A 100-gallon prover holds 23,100 cu.in. Therefore, 23.1 cu.in. represents 0.1% error.

### Meter Tolerance

In the United States, the National Institute of Standards and Technology, in NIST Handbook 44 specifies plus or minus tolerances according to the following:

Indication of Device	Tolerance			
	Acceptance Test	Maintenance Test	Special Test	Repeatability
USA-Wholesale	+/- 0.20%	+/- 0.30%	+/- 0.50%	0.12%
USA-Vehicle	+/- 0.15%	+/- 0.30%	+/- 0.45%	0.12%

In Europe, the plus or minus meter tolerances are specified by OIML R117-1. In Canada, the plus or minus tolerances are specified by the National Measurement Act.

Indication of Device	Tolerance			
	Acceptance Test	Maintenance Test	Special Test	Repeatability
Europe	+/- 0.30%	+/- 0.50%	N/A	0.20%
Canada	+/- 0.1875%	+/- 0.375%	N/A	0.15%

Acceptance tolerances apply to new meters and repaired meters after reconditioning. Maintenance tolerances apply to meters already in service. Special tolerances apply to meters in the United States only, for special instances as determined by weights and measures officials.

### Changing Meter Calibration

Refer to meter literature for method of changing meter calibration. Any change in the meter calibration adjustment will change the delivery in the same amount for all rates of flow. That is, the calibration curve retains its shape, but is moved up or down. Therefore, if a meter tests satisfactorily at full flow, but drops off too much at low flow, changing the calibration will not remedy this condition; it will bring the low flow test to 100%, but it will also bring the full flow above 100% by the same amount that the low flow was raised. A condition of this kind is caused either by the metering system, need for meter cleaning or repairs, or because of an attempt to retain accuracy below the minimum recommended rate of flow for the meter.

### Repeatability

Consider the percentage error readings from each test run made at the same flow rate and draft size (calibration run). The difference between the reading with the highest value and that with the lowest value must be less than a value which is 40% of the applicable maintenance tolerance. For example, a meter in the USA, this would be 0.12% (0.30% x 0.4 = 0.12%). The percentage error of all test runs at each flow rate must still be within the applicable tolerance.

## Meter Calibration (Continued)



### Temperature Correction

If the testing conditions are such that the temperature of the liquid differs by more than a few degrees between the meter and the prover, it is advisable to apply temperature correction to the prover readings. Thermowells must be installed into the system and temperature readings must be taken during test runs at the meter and in the prover. Corrections are made by the use of API Volume Correction Factor Tables.

## Calibration Adjustment

One complete turn of the adjuster barrel is equal to 1 gallon in 100 gallons or 1% of delivered volume. The adjuster body will show divisions of 1%, while the adjuster barrel has divisions of 0.02%. For volumes other than 100 gallons, the following formula may be used to calculate the Adjuster percent to increase or decrease prover volume.

$$\frac{\text{Volume on Prover minus Volume on Meter Counter}}{\text{Volume on Prover}}$$

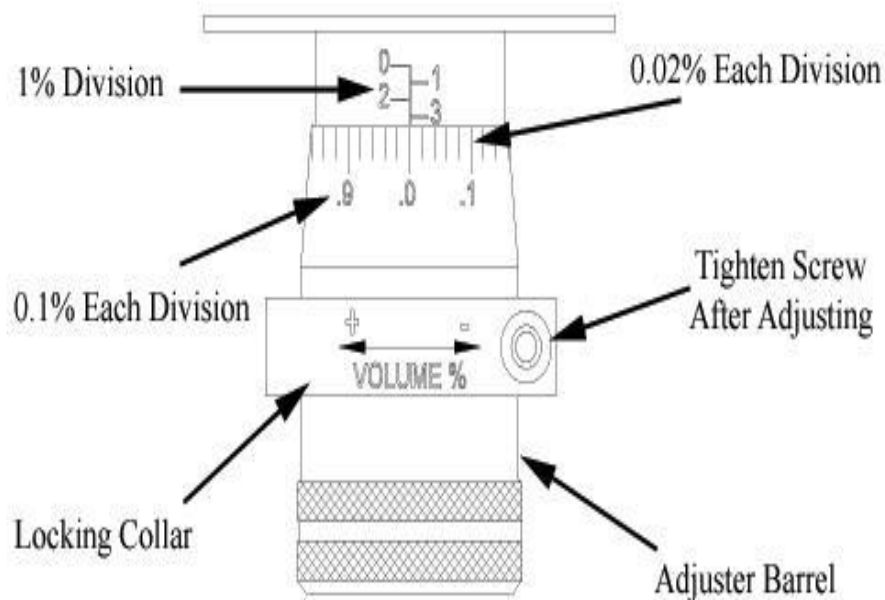

## Split Compartment Test



**Purpose:** A product depletion test verifies the proper operation of the air elimination system when the storage tank for the product being measured is pumped dry. This test is necessary for meters that may drain a tank completely, such as a vehicle tank meter.

### Multiple-Compartment Test Procedure:

- 1) Begin the test from a compartment (ideally the largest compartment) containing an amount of fuel equal to or less than one-half the nominal capacity of the prover being used. Operate the meter at the normal full flow rate until the compartment is empty. There are several methods for determining that the compartment is empty. There may be a significant change in the sound of the pump. There may be visual evidence that the compartment has run dry. The meter register may stop entirely or may begin to count erratically (pause, resume running, then pause, then run again.)
- 2) Continue the test until the meter indication stops entirely for at least 10 seconds. If this occurs, proceed to Step 3. If the meter indication fails to stop entirely for a period of 10 seconds, continue to operate the system in this condition for 3 minutes.
- 3) Close the valve from the empty compartment, and if top filling, close the nozzle or valve at the end of the delivery hose. Open the valve from another compartment containing the same product. Carefully open the valve at the end of the delivery hose. Pockets of vapor or air may cause product to splash out of the prover. The test results may not be valid if product is splashed out of the prover. Appropriate attire and protection is required, and always use caution.
- 4) Continue delivering product at the normal full flow rate until the liquid level in the prover reaches the nominal capacity.
- 5) Close the delivery nozzle or valve and stop the meter. Allow any entrained air to settle, then read the prover sight gauge.
- 6) Compare the meter indication with the actual delivered volume in the prover.
- 7) Calculate the meter error. Apply the Product Depletion Test Tolerance to determine whether the meter error is within acceptable limits. Refer to NIST Handbook 44 for further information.

### Product Depletion Test Tolerance for Vehicle-Tank Meters:

Marked Maximum Flow Rate	Product Depletion Test Tolerance
Less than 100 GPM (380 LPM)	0.5%
100 GPM (380 LPM) or greater	0.6%

The results of the product depletion test may fall outside of the applicable test tolerance as this is a stand-alone test.

The test draft should be equal to at least the amount delivered by the device in 1 minute at its maximum discharge rate, and in no case should it be less than 50 gallons.

## Split Compartment Test (Continued)



### Single Compartment Test Procedure:

The test of single-compartment tanks is easier to accomplish if there is a quick-connect hose coupling between the compartment valve and the pump that supplies product to the meter. If the system does not have quick-connect couplings between the compartment and the meter, an additional source of sufficient product at the test site is required.

Without a quick-connect coupling:

- 1) Begin the test from a compartment (ideally the largest compartment) containing an amount of fuel equal to or less than the nominal capacity of the prover being used. Operate the meter at the normal full flow rate until the compartment is empty. There are several methods for determining that the compartment is empty. There may be a significant change in the sound of the pump. There may be visual evidence that the compartment has run dry. The meter register may stop entirely or may begin to count erratically (pause, resume running, then pause, then run again.)
- 2) Continue the test until the meter indication stops entirely for at least 10 seconds. If this occurs, proceed to Step 3. If the meter indication fails to stop entirely for a period of 10 seconds, continue to operate the system in this condition for 3 minutes.
- 3) Close the valve from the empty compartment, and if top filling, close the nozzle or valve at the end of the delivery hose. Stop the pump and load sufficient product from the alternate source into the supply compartment that feeds the meter being tested. Allow a brief time for the product to stand in the compartment to allow entrained vapor or air to escape.
- 4) Open the compartment valve and restart the pump without resetting the meter to zero. Carefully open the nozzle or valve at the end of the delivery hose. Pockets of vapor or air may cause product to splash out of the prover. The test results may not be valid if product is splashed out of the prover. Appropriate attire and protection is required, and always use caution.
- 5) Continue delivering product at the normal full flow rate until the liquid level in the prover reaches the nominal capacity.
- 6) Close the delivery nozzle or valve and stop the meter. Allow any entrained air to settle, then read the prover sight gauge.
- 7) Compare the meter indication with the actual delivered volume in the prover.
- 8) Calculate the meter error. Apply the Product Depletion Test Tolerance to determine whether the meter error is within acceptable limits. Refer to NIST Handbook 44 for further information.

## Split Compartment Test (Continued)



With a quick-connect coupling:

- 1) During a normal full flow test run, close the compartment valve when the prover is approximately one-half full to its normal capacity. Then slowly and carefully disconnect the quick-connect coupling, allowing the pump to drain the supply line.
- 2) Continue the test until the meter indication stops entirely for at least 10 seconds. If the meter fails to stop entirely for at least 10 seconds, continue to operate the system for 3 minutes.
- 3) After 10 seconds (or 3 minutes if the meter indication did not stop entirely), close the delivery nozzle or valve at the end of the delivery hose if top filling.
- 4) Disconnect and reconnect the quick-connect coupling and open the compartment valve.
- 5) Carefully open the nozzle or valve at the end of the delivery hose. Pockets of vapor or air may cause product to splash out of the prover. The test results may not be valid if product is splashed out of the prover. Appropriate attire and protection is required, and always use caution.
- 6) Continue the delivery of product at the normal full flow rate until the liquid level in the prover reaches the prover's nominal capacity.
- 7) Close the delivery nozzle or valve. Stop the pump. Allow any entrained air to settle, then read the prover sight gauge.
- 8) Compare the meter indication with the actual delivered volume in the prover.
- 9) Calculate the meter error. Apply the Product Depletion Test Tolerance to determine whether the meter error is within acceptable limits. Refer to NIST Handbook 44 for further information.

Product Depletion Test Tolerance for Vehicle-Tank Meters:

Marked Maximum Flow Rate	Product Depletion Test Tolerance
Less than 100 GPM (380 LPM)	0.5%
100 GPM (380 LPM) or greater	0.6%

The results of the product depletion test may fall outside of the applicable test tolerance as this is a stand-alone test.

The test draft should be equal to at least the amount delivered by the device in 1 minute at its maximum discharge rate, and in no case should it be less than 50 gallons.

## Maintenance



### ***!WARNING!***

Test equipment should be grounded to prevent a possible spark. Test area should have no ignition source. Operators should wear personal protection and prevent any product exposure and environmental issues.

- 1) Keeping accurate maintenance and calibration records can be an excellent tool in determining the frequency of inspection or maintenance for a system. As the meter wears, the calibration will be affected and require adjustment. A personality profile can be created for each meter to help guide in a maintenance schedule.
- 2) Great care should be utilized in the maintenance of the metering system. Personal safety protection, environmental hazards, and government regulations need to be the foremost priority. Only fully trained personnel should be involved in maintenance. Failure to use original TCS replacement parts will void any Weights and Measures approvals, warranty and risk damage to the meter system.
- 3) ALWAYS RELIEVE INTERNAL SYSTEM PRESSURE TO ZERO BEFORE DISASSEMBLY OR INSPECTION.
- 4) SERIOUS INJURY OR DEATH FROM FIRE OR EXPLOSION COULD RESULT FROM MAINTENANCE OF AN IMPROPERLY DEPRESSURIZED AND EVACUATED SYSTEM.
- 5) Total Control Systems flow meters and accessories are often used with petroleum, solvents, chemicals, and other liquids that may be explosive, extremely flammable, very toxic, oxidizing, and corrosive. Severe injury or fatalities may arise if appropriate safety precautions are not followed.
- 6) Before replacing or cleaning filter/strainer screen, the electrical system must be turned off. Product must be drained from system. Collect all product and return to storage or dispose of properly. Replace all drain plugs that were removed. Personal safety protection must be worn at this time. Make sure there is adequate ventilation in the area. The metering system will not completely drain so extra product must be collected when the strainer cover is removed. Clean the screen once a week, or more often if there is a lot of sediment in the system. Ensure that there is no ignition source and that the system is grounded. Replace all plugs that were removed for drainage.
- 7) The metering system is heavy and awkward so take precaution to handle it properly.
- 8) Do not use force to disassemble or use a screwdriver to pry open any part of the metering system. Have the proper tools available before trying to repair the meter system. Use caution when handling the internal parts as they can be sharp and heavy. Do not drop the housing or rotors as they can cause injury and can be damaged or destroyed. Use caution when inspecting and aligning the timing gears and rotors as they can pinch fingers. Turn these slowly to verify smooth operation.
- 9) When inspecting the spring loaded preset valves do not place anything inside the housing, as the action of the valve will pinch this object when the valve closes.

## Maintenance (Continued)



### ***!WARNING!***

Test equipment should be grounded to prevent a possible spark. Test area should have no ignition source. Operators should wear personal protection and prevent any product exposure and environmental issues.

- 10) When removing gaskets or O-rings, carefully check for damage or corrosion. Any cracked, rough, worn, elongated or swollen O-rings must be replaced. When replacing the O-rings, place grease along the inside of the O-ring groove or completely around the O-ring to help the O-ring stay in the O-ring groove during assembly. If an O-ring is pinched or not in the O-ring groove, the meter system will leak and cause serious problems to the environment and equipment. Collect all replaced parts and dispose of properly.
- 11) Do not weld onto any part of the meter system or accessories as this will weaken the part and allow for leaks.
- 12) Bolts and screws must be coated with Anti-Seize lubricant. Follow the torque specifications for each flow meter, air eliminator, strainer or preset valve bolt found on page 31.
- 13) Recommended levels of maintenance and inspection will depend upon the system variables, such as the characteristics of the products being measured (viscosity, corrosiveness, suspensions, etc.), system pressure requirements, government or company regulations, and the age of the metering system. If hydrostatic testing is required, the system pressure should not exceed 1.5 times the marked meter pressure. It is not recommended to pneumatically test the meter system at any time.
- 14) If any component of the meter system is removed from the system, it should be thoroughly flushed with a compatible liquid. After this is done, immediately refill the meter or accessory with a compatible liquid to prevent corrosion and water build up.

## Storage Instructions



Short periods of non-use of the meter (a week or less) should present no problem, provided that the meter remains full of product. For long periods of non-use, such as winter storage, the following procedure is recommended.

- 1). To store the meter when it is left in line, flush the system with clean water until 70-80 gallons of water have passed through the meter.
- 2). Pump a 50% anti-freeze / 50% water solution through the entire system (100% RV antifreeze may be used instead). With the pump running, shut off a valve downstream from the meter, making sure that the system is full of anti-freeze solution to that point. Then close an upstream valve, such that the meter remains full of anti-freeze solution.
- 3). Remove the register from the meter, and lubricate the drive coupling shaft. After lubrication, reassemble the register onto the meter.

When starting the system after a period of storage, it is recommended that the meter calibration be rechecked.



# 700-20 / 700-25 Dimensions

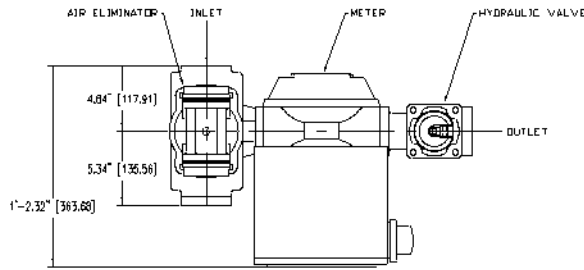

Meter shown with these options:

- Meter
- Air Eliminator
- Strainer
- Hydraulic Valve
- Air Check Valve
- Register
- Preset
- Printer

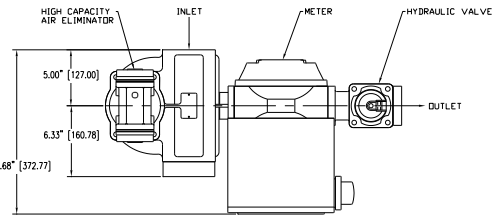
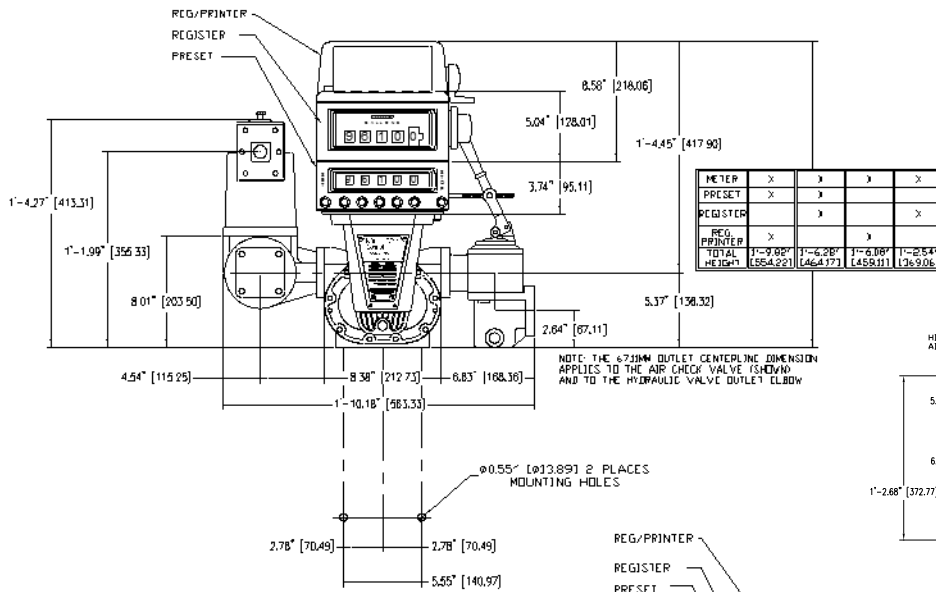

Meter shown with these options:

- Meter
- Air Eliminator
- High Capacity Strainer
- Hydraulic Valve
- Air Check Valve
- Register
- Preset
- Printer

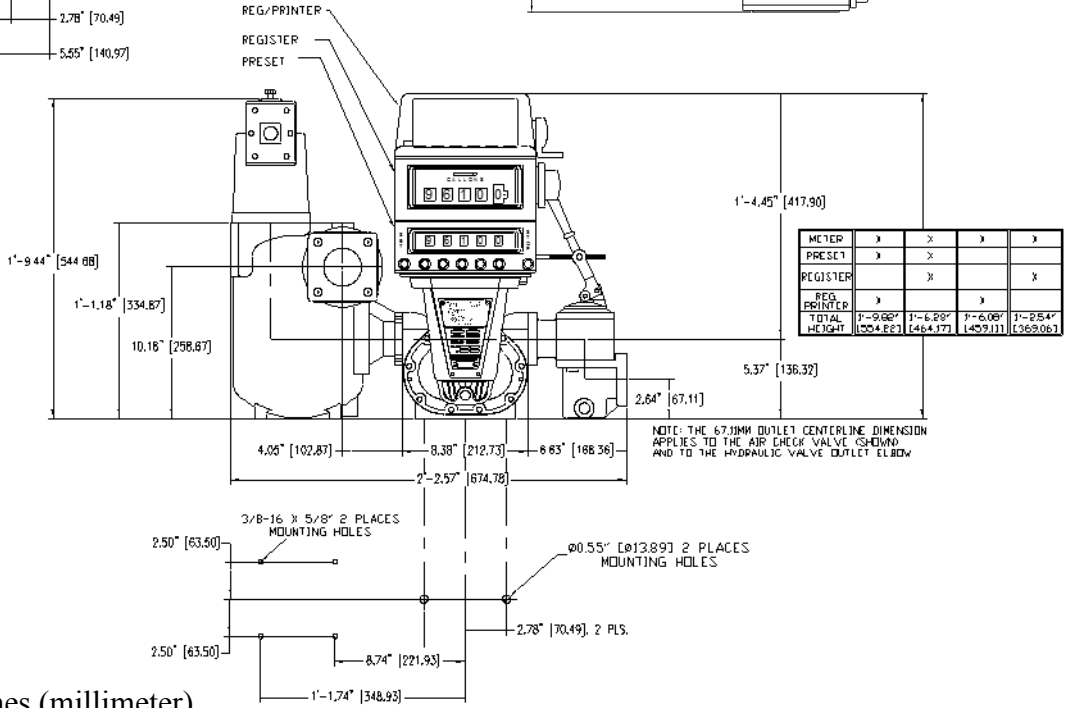

All measurements are in inches (millimeter)

# 700-20 / 700-25 Meter Assembly

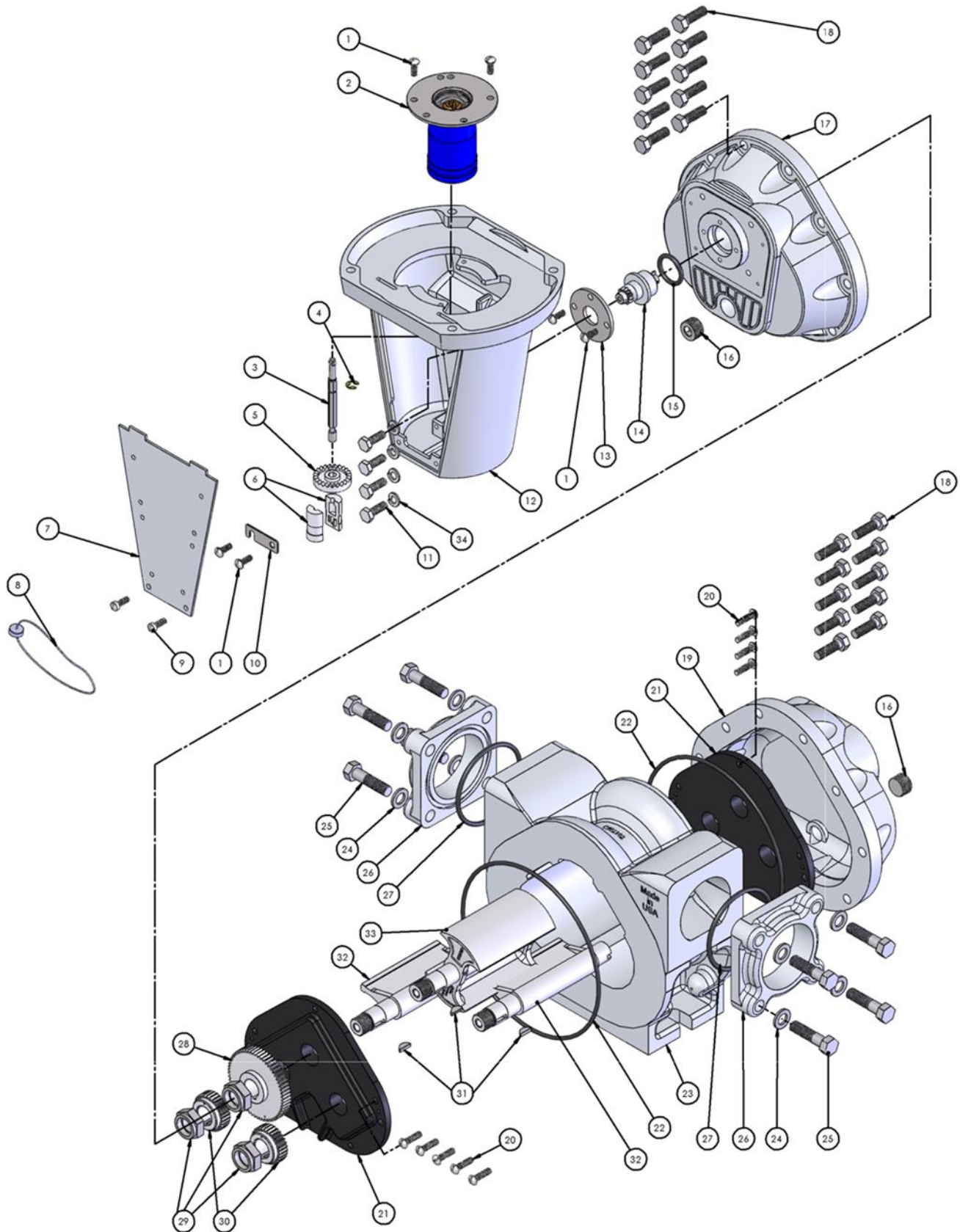

## 700-20 / 700-25 Meter Assembly

Item	Description	Qty	700-20								700-25	
			SP	SPA	SPD	IP	IC	AF	SS	SSD	SPA	SPD
1	Round Head Screw	6	1-128279	1-128279	1-128279	1-128279	1-128279	1-128279	1-128279	1-128279	1-128279	1-128279
2	Adjuster Assembly	1	700100	700100	700100	700100	700100	700100	700100	700100	700100	700100
3	Drive Shaft	1	700019	700019	700019	700019	700019	700019	700019	700019	700019	700019
4	E-Ring	1	700016	700016	700016	700016	700016	700016	700016	700016	700016	700016
5	Acetal Face Gear	1	700018	700018	700018	700018	700018	700018	700018	700018	700018	700018
6	Acetal Bushing	2	700020	700020	700020	700020	700020	700020	700020	700020	700020	700020
7	Adjuster Cover Plate	1	700017	700017	700017	700017	700017	700017	700017	700017	700017	700017
8	Seal Wire	1	1-118849	1-118849	1-118849	1-118849	1-118849	1-118849	1-118849	1-118849	1-118849	1-118849
9	Drilled Head Screw	2	700042	700042	700042	700042	700042	700042	700042	700042	700042	700042
10	Drive Shaft Retainer	1	700022	700022	700022	700022	700022	700022	700022	700022	700022	700022
11	Head Mount Screw	4	700040	700040	700040	700040	700040	700040	700040	700040	700040	700040
12	Register Support	1	700200	700200	700200	700200	700200	700200	700200	700200	700200	700200
13	Packing Retaining Plate	1	700015	700015	700015	700015	700015	700015	700015	700015	700015	700015
14A	2:1 Packing Capsule Assy., STD	1	700150	700150	700155	700155	700155	700155	700155	700350	700150	700155
14B	1:1 Packing Capsule Assy.	1	700170	700170	700175	700175	700175	700175	700175	-	700170	700175
15	Packing O-ring	1	700009	700009	700010	700010	700010	700010	700010	700809	700009	700010
16	Plug	2	700024	700024	700024	700024	700024	700024	700024	700024	700024	700024
17	Front Cover	1	702500	702500	702503	702500	702500	702503	702502	702524	702500	702503
18A	Cap Screw	16	700026	700026	700026	700026	700026	700026	700026	700026	700026	700026
18B	Drilled Cap Screw	4	700026D	700026D	700026D	700026D	700026D	700026D	700026D	700026D	700026D	700026D
19	Rear Cover	1	702550	702550	702553	702550	702550	702553	702552	702572	702550	702553
20	Round Head Screw	10	702014	702014	702014	702014	702014	702014	702014	702014	702014	702014
21	Bearing Plate	2	702230	702235	702235	702230	702225	702225	702245	702231	702225	702225
22	Housing O-ring	2	702001	702001	702002	702002	702002	702002	702002	702801	702001	702002
23	Housing	1	702110	702110	702120	702110	702110	702120	702125	702114	702110	702120
24	Flat Washer	8	702018	702018	702018	702018	702018	702018	702018	702018	702018	702018
25A	Cap Screw	4	702017	702017	702017	702017	702017	702017	702017	702017	702017	702017
25B	Drilled Cap Screw	4	702017D	702017D	702017D	702017D	702017D	702017D	702017D	702017D	702017D	702017D
26A	Flange, 2" NPT	2	702600	702600	702601	702600	702600	702601	702602	702602P	702600	702601
26B	Flange, 2" BSPT	2	702603	702603	702611	702603	702603	702611	702612	702612P	702603	702611
27	Flange O-ring	2	702012	702012	702013	702013	702013	702013	702013	702812	702012	702013
28	Blocking Gear	1	702351	702351	702351	702351	702351	702351	702350	702353	702351	702351
29	Rotor Lock Nut	3	702010	702010	702010	702010	702010	702010	702020	702020	702010	702010
30	Displacement Gear	2	702451	702451	702451	702451	702451	702451	702450	702453	702451	702451
31	Rotor Key	3	702008	702008	702008	702008	702008	702008	702008	702008	702008	702008
32	Displacement Rotor	2	702405	702405	702422	702410	702410	702415	702415	702424	702405	702422
33	Blocking Rotor	1	702305	702305	702322	702310	702310	702315	702315	702324	702305	702322
34	Lock Washer	4	700071	700071	700071	700071	700071	700071	700071	700071	700071	700071

### Meter Cold Weather Seal Kit—TCS 702078

#### Contents:

(15) Packing O-Ring	Qty. 1
(22) Housing O-ring	Qty. 2
(27) Flange O-ring	Qty. 2

All seals are low temperature Nitrile Rubber

# 730-20 Air Eliminator Assembly

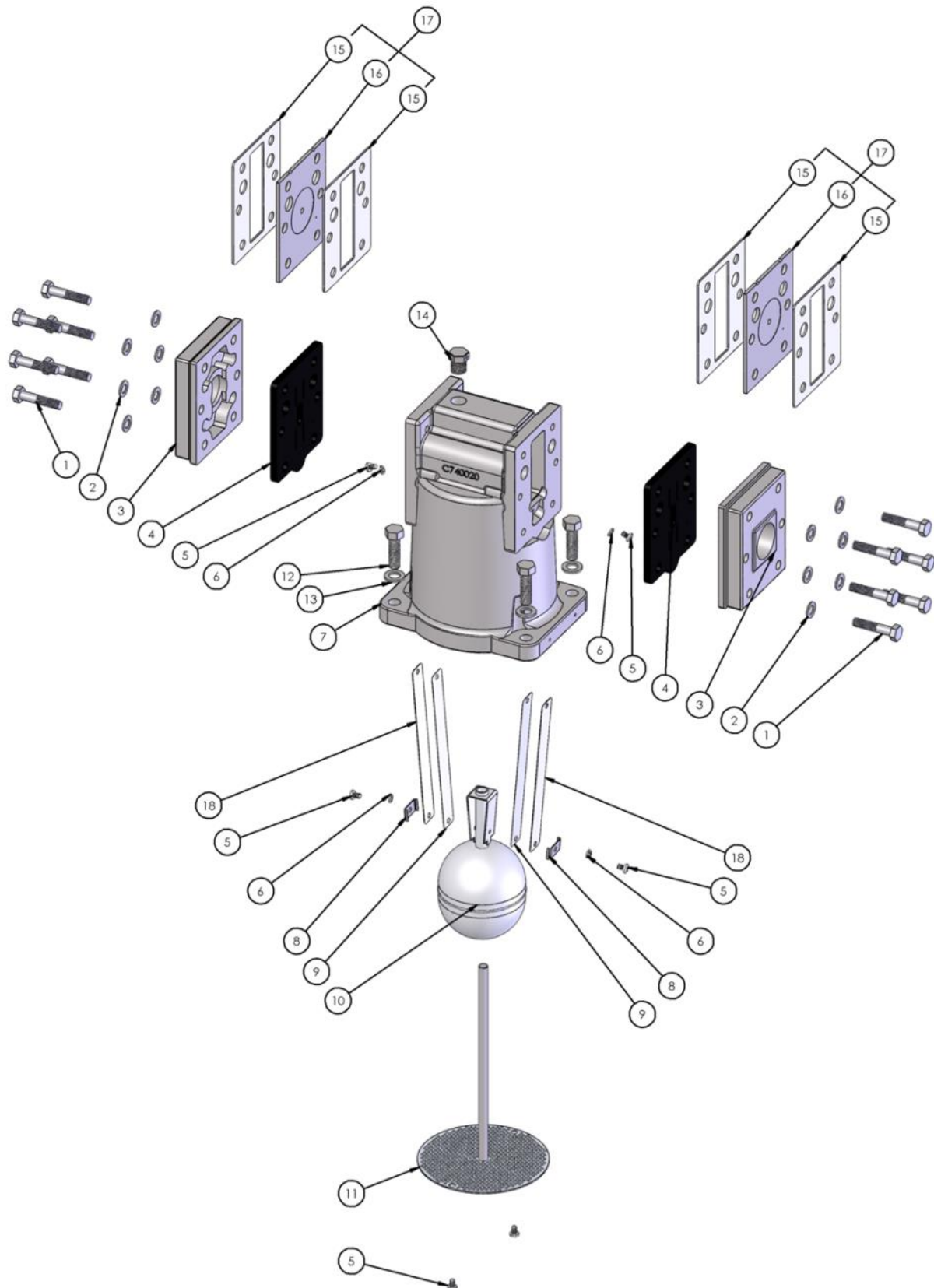

## 730-20 Air Eliminator Assembly

Item	Description	Qty	730-20					
			SP	SPD	IP	AF	SS	SSD
1A	Cap Screw	8	740050	740050	740050	740050	740050	740050
1B	Drilled Cap Screw	4	740050D	740050D	740050D	740050D	740050D	740050D
2	Ring Washer	12	740051	740051	740051	740051	740051	740051
3A	Outlet Cover, NPT	2	740010	740016	740010	740016	740018	P740018
3B	Outlet Cover, BSPT	2	740710	740716	740710	740716	740718	P740718
4	Encapsulated Valve Plate	2	740205	740215	740215	740215	740215	740205
5	Screw	4	740030	740030	740030	740030	740030	740030
6	Split Lock Washer	2	740017	740017	740017	740017	740017	740017
7	Air Eliminator Housing	1	740020	740022	740020	740022	740024	P740024
8	Retaining Clip	2	740012	740012	740012	740012	740012	740012
9	PTFE Reed Strip	2	-	740077	740077	740077	740077	740077
10	Float Assembly	1	740013	740013	740013	740013	740013	740013
11	Diffuser & Shaft Assy.	1	740035	740035	740035	740035	740035	740035
12A	Cap Screw	2	700054	700054	700054	700054	700054	700054
12B	Drilled Cap Screw	2	700054D	700054D	700054D	700054D	700054D	700054D
13	Flat Washer	4	702018	702018	702018	702018	702018	702018
14	Plug	1	2-126146	2-126146	2-126146	2-126146	2-126146	2-126146
15	Plate Seal	4	740005	740004	740004	740004	740004	-
16	Valve Plate	2	740038	740006	740006	740006	740006	-
17	Valve Plate Kit	2	740138	740106	740106	740106	740106	-
18	Reed Valve	2	740007	740007	740007	740007	740007	740007

# 720-20 Strainer / 725-20 High Capacity Strainer Assembly

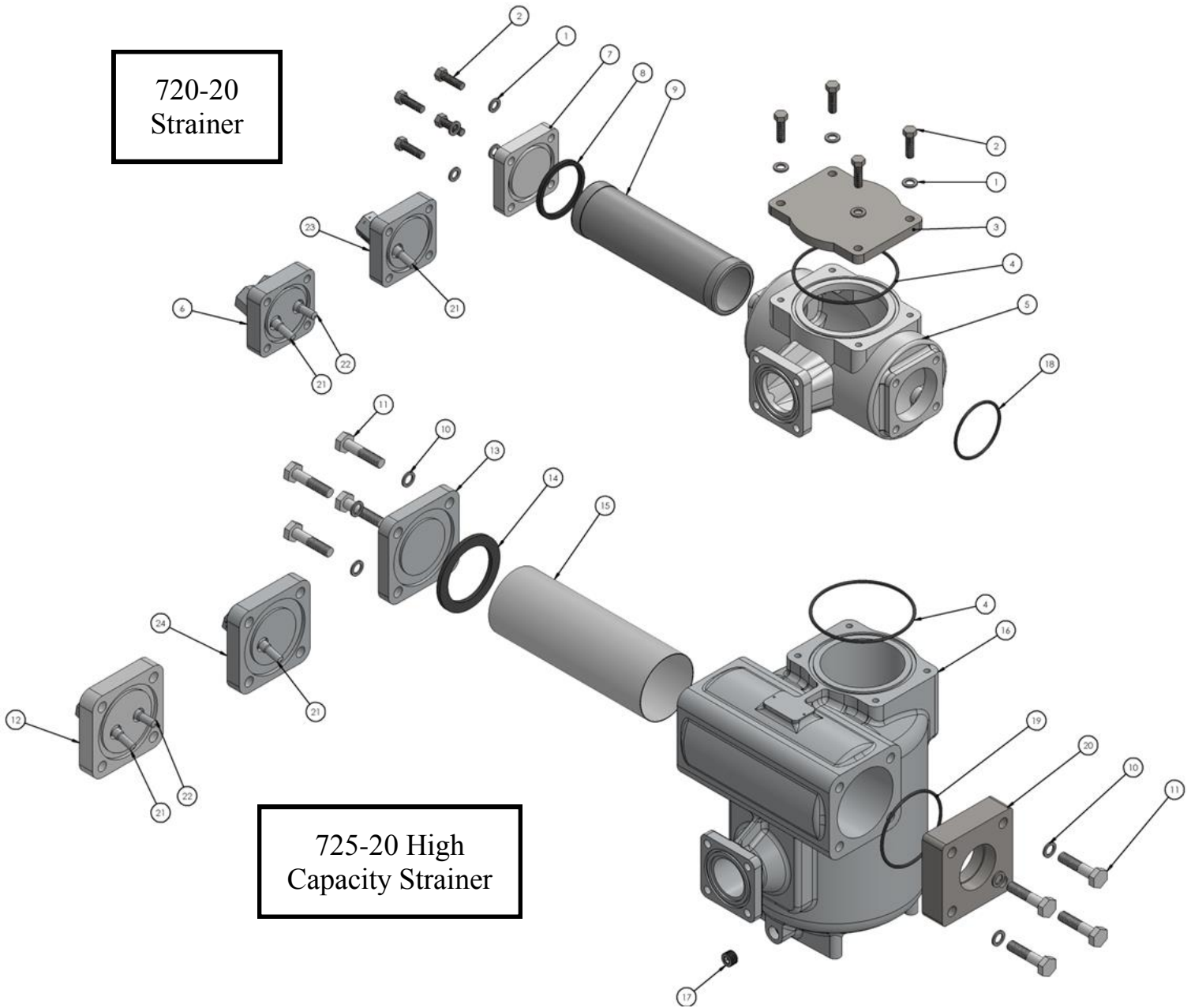

## 720-20 Strainer / 725-20 High Capacity Strainer Assembly

Item	Description	Qty	720-20						725-20
			SP	SPD	IP	AF	SS	SSD	SP
1	Flat Washer	8	702018	702018	702018	702018	702018	702018	702018
2A	Cap Screw	6	700054	700054	700054	700054	700054	700054	700054
2B	Drilled Cap Screw	2	700054D	700054D	700054D	700054D	700054D	700054D	700054D
3	Strainer Cover, Optional	1	740041	740042	740041	740042	740042	-	740041
4	Top Seal O-ring	1	740009	740019	740019	740019	740019	740809	740009
5	Strainer Housing	1	742021	742022	742021	742022	742023	P742023	-
6	Basket Cover, Two 1/2" NPT Ports	1	742055	742056	742055	742056	742057	-	-
7	Basket Cover, STD	1	742050	742052	742050	742052	742053	P742053	-
8	Seal Ring	1	742003	742004	742004	742004	742004	742803	-
9A	0.050 Strainer Basket, STD	1	-	-	742005	742005	742005	-	-
9B	40M Strainer Basket, STD	1	742010	742010	-	-	-	P742010	-
9C	80M Strainer Basket	1	742015	742015	-	-	-	-	-
9D	100M Strainer Basket	1	742025	742025	-	-	-	-	-
10	Flat Washer	8	-	-	-	-	-	-	703018
11A	Cap Screw	4	-	-	-	-	-	-	703017
11B	Drilled Cap Screw	4	-	-	-	-	-	-	703017D
12	Basket Cover, Two 1/2" NPT Ports	1	-	-	-	-	-	-	743055
13	Basket Cover, STD	1	-	-	-	-	-	-	743050
14	Seal Ring	1	-	-	-	-	-	-	743003
15A	40M Strainer Basket, STD	1	-	-	-	-	-	-	743010
15B	80M Strainer Basket	1	-	-	-	-	-	-	743015
15C	100M Strainer Basket	1	-	-	-	-	-	-	743025
16	High Capacity Strainer Housing	1	-	-	-	-	-	-	745021
17	Plug	1	-	-	-	-	-	-	700024
18	Flange O-ring	1	702012	702072	702013	702013	702013	702812	-
19	Flange O-ring	1	-	-	-	-	-	-	703012
20A	Flange; 3" x 2" NPT	1	-	-	-	-	-	-	703615
20B	Flange; 3" x 2" BSPT	1	-	-	-	-	-	-	703616
21	3/8" x 1/2" NPT Thermowell	1	740300	740400	740300	740400	740400	-	740300
22	1/2" x 1/2" NPT Thermowell	1	740305	740405	740305	740405	740405	-	740305
23	Basket Cover, One 1/2" NPT Port	1	742155	742156	742155	742156	742157	-	-
24	Basket Cover, One 1/2" NPT Port	1	-	-	-	-	-	-	743155

Strainer Cold Weather Seal Kit—TCS 742078 Contents:  
All seals are low temperature Nitrile Rubber

(4) Top Seal  
(8) Seal Ring  
(14) Flange O-ring

Qty. 1  
Qty. 1  
Qty. 2

Check us out at [www.TCSmeters.com](http://www.TCSmeters.com)!

# 750-20 Hydraulic Preset Valve Assembly

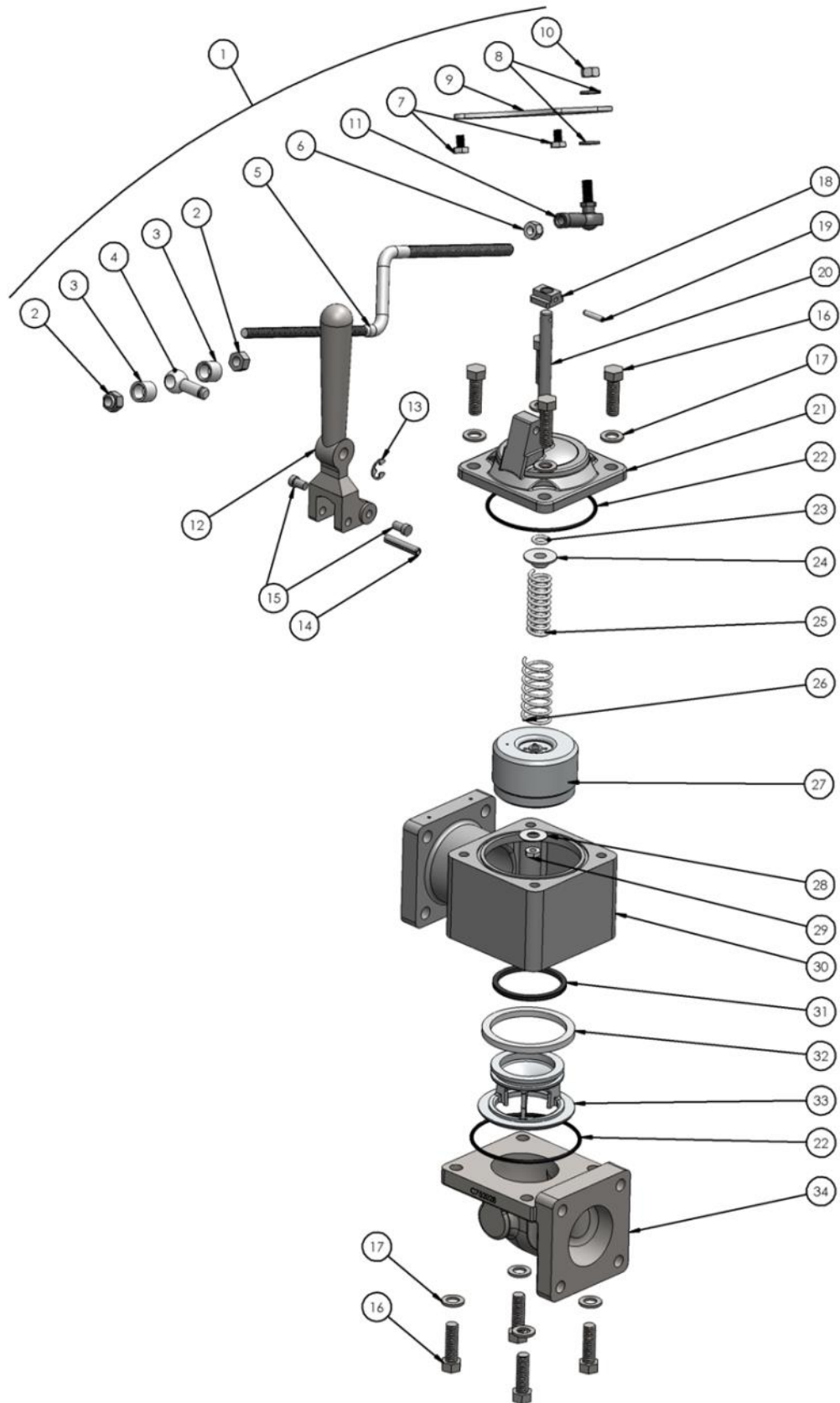



## 750-20 Hydraulic Preset Valve Assembly

Item	Description	Qty	750-20				
			SP	IP	AF	SS	SSD
1	Linkage Assembly Kit	1	752002KT	752002KT	752002KT	752002KT	752002KT
2	Linkage Lock Nut	2	750001	750001	750001	750001	750001
3	Linkage Sleeve	2	750002	750002	750002	750002	750002
4	Linkage Spherical Pivot	1	750003	750003	750003	750003	750003
5	Linkage Arm	1	752001	752001	752001	752001	752001
6	Hex Nut	1	750010	750010	750010	750010	750010
7	Linkage Screw	2	750011	750011	750011	750011	750011
8	Flat Washer	2	68001	68001	68001	68001	68001
9	Preset Bracket	1	752099	752099	752099	752099	752099
10	Locking Nut	1	750012	750012	750012	750012	750012
11	Ball & Stud	1	753053	753053	753053	753053	753053
12	Operating Lever	1	752010	752010	752010	752010	752010
13	Linkage E-Ring	1	750004	750004	750004	750004	750004
14	Roll Pin	1	752004	752004	752004	752004	752004
15	Step Pin	2	752005	752005	752005	752005	752005
16A	Cap Screw	4	700054	700054	700054	700054	700054
16B	Drilled Cap Screw	4	700054D	700054D	700054D	700054D	700054D
17	Flat Washer	8	702018	702018	702018	702018	702018
18	Bushing	1	752006	752006	752006	752006	752006
19	Roll Pin	1	752007	752007	752007	752007	752007
20	Valve Shaft	1	752008	752008	752008	752008	752008
21	Valve Cap	1	752015	752015	752017	752018	752018
22	Body O-ring	2	752044	752045	752045	752045	752045
23	O-ring	1	752011	752012	752012	752012	752012
24	O-ring Retainer	1	752013	752013	752013	752013	752013
25	Internal Spring	1	752019	752019	752019	752019	752019
26	External Spring	1	752014	752014	752014	752014	752014
27	Piston	1	752020	752020	752022	752022	752022
28	Washer	1	752023	752023	752023	752023	752023
29	Lock Nut	1	752024	752024	752024	752024	752024
30	Valve Body	1	752040	752040	752042	752043	752043
31	Upper Seal	1	752035	752036	752036	752036	752036
32	Lower Seal	1	752033	752034	752034	752034	752034
33	Piston Guide	1	752030	752031	752032	752032	752032
34	Elbow	1	752041	752041	752027	752028	752028

Valve Cold Weather Seal Kit—TCS 752078

Contents:

(32) Lower Seal	Qty. 1
(23) Shaft O-Ring	Qty. 1
Flange O-ring	Qty. 2

All seals are low temperature Nitrile Rubber, FKM or PTFE

(31) Upper Seal	Qty. 1
(22) Body O-ring	Qty. 2

## 760-20SP / 765-20SP Air Check Valve Assembly

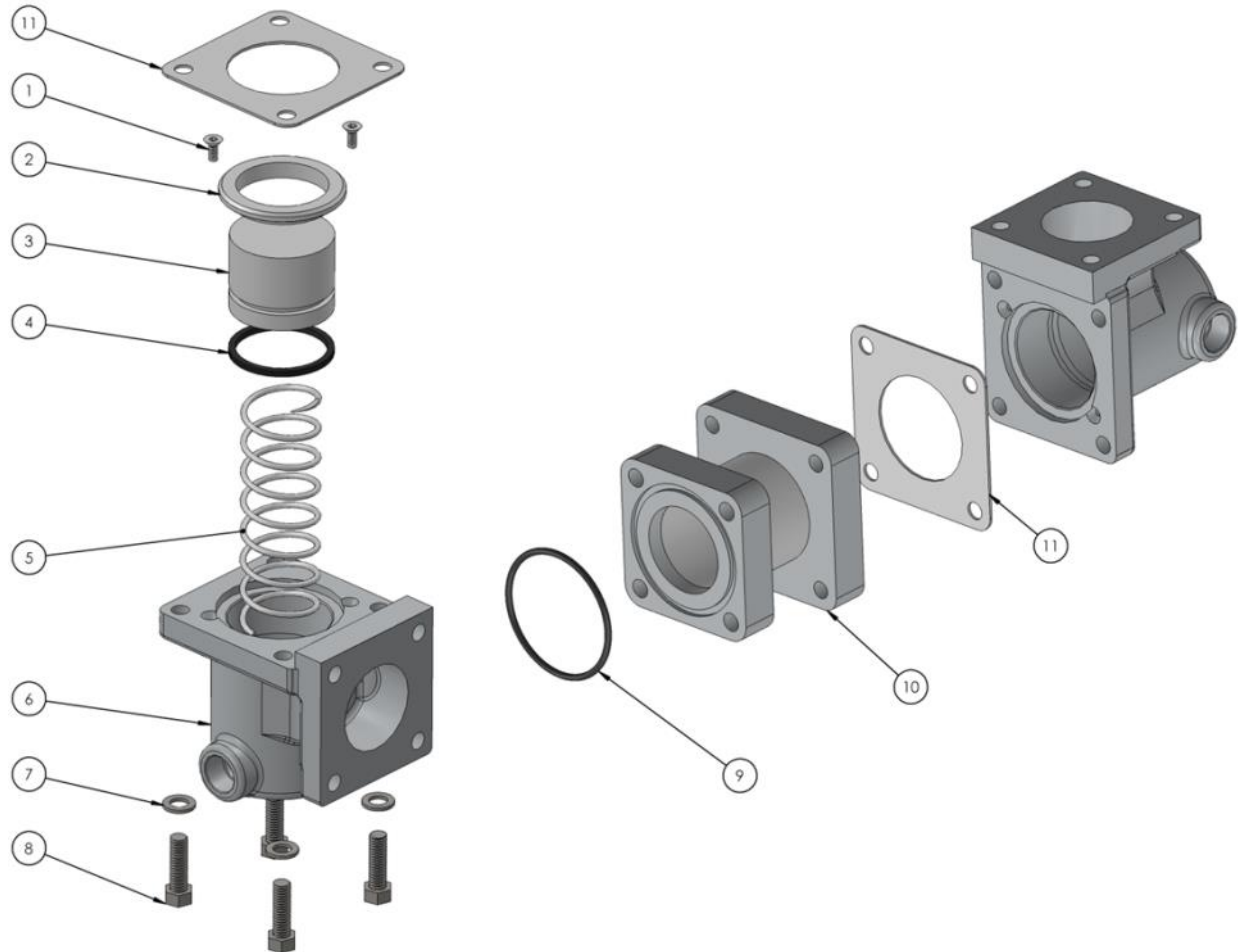

Item	Description	Quantity	760-20	765-20
			SP	SP
1	Screw	2	792004	792004
2	Ring	1	792003	792003
3	Poppet	1	792002	792002
4	Gasket	1	792005	792005
5	Compression Spring	1	792001	792001
6A	Housing; 1/2" NPT	1	792011	792011
6B	Housing, 1/2" BSPT	1	792711	792711
7	Flat Washer	4	702018	702018
8A	Cap Screw	2	792015	792015
8B	Drilled Cap Screw	2	792015D	792015D
9	Adapter O-ring; 765 Air Check	1	-	702012
10	Adaptor; 765 Air Check	1	-	702665
11	Valve Gasket	1	752039	752039

## Torque Specifications

### 700-20/25 METER ASSEMBLY

Part Number & Description	Tool	Bolt/Nut Size	Foot Lbs.		Newton Meter	
			Unlubricated	Lubricated	Unlubricated	Lubricated
TCS 700026 Cover Screws	1/2" hex wrench/socket	5/16-18 UNC 2B	11	6.6	14.9	8.9
TCS 700040 Counter Support	7/16" hex wrench/socket	1/4-20 UNC 2B	6.3	3.8	8.5	5.2
TCS 702014 Bearing Plate	slotted screwdriver	10-24 UNC 2B	1.9	1.1	2.6	1.5
TCS 1-128279 Dust Cover	slotted screwdriver	10-24 UNC-2B	1.9	1.1	2.6	1.5
TCS 702010 Rotor Gear	15/16" hex wrench/socket	5/8-18	40	28	54	38

### 740-20 AIR ELIMINATOR/STRAINER ASSEMBLY

Part Number & Description	Tool	Bolt/Nut Size	Foot Lbs.		Newton Meter	
			Unlubricated	Lubricated	Unlubricated	Lubricated
TCS 740050 Cover Plate	1/2" hex screw wrench/socket	5/16-18 UNC 2B	11	6.6	14.9	8.9
TCS 701017 Cap Screws	9/16" hex screw wrench/socket	3/8-16 UNC 2B	19.7	11.8	26.7	16.0
TCS 740030 Reed & Diffuser	slotted screwdriver	8-32 UNC 2B	1.65	1.0	2.2	1.4

### 750-20 HYDRAULIC PRESET VALVE ASSEMBLY

Part Number & Description	Tool	Bolt/Nut Size	Foot Lbs.		Newton Meter	
			Unlubricated	Lubricated	Unlubricated	Lubricated
TCS 701017 Cover & Elbow	9/16" hex screw wrench/socket	3/8-16 UNC 2B	19.7	11.8	26.7	16.0
TCS 752024 Piston Lock	7/16" hex nut Wrench/socket	1/4-20 UNF 3B	6.3	3.8	8.5	5.2

This Torque Chart is for 18-8 Stainless Steel Bolts

\*\*Values can be +/- 10% of value listed\*\*

## Drive Components



### Removing the Dust Cover

- 1) Cut dust cover seal. Remove the dust cover screws with a standard flathead screwdriver.
- 2) Note the setting on calibration adjuster.
- 3) Note the position of the drive gear (either above or below the packing gland pinion).

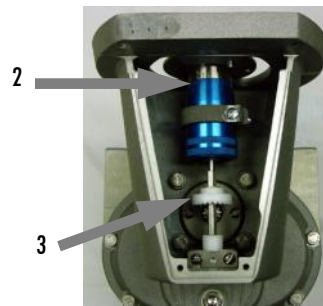

### Removing the Adjuster

- 1) Loosen the retaining screws using a standard flathead screwdriver.
- 2) Slide the retaining clip up and over to the right side.



- 3) From the top, remove the screws to adjuster plate.
- 4) Lift adjuster out of the counter adapter.
- 5) Remove the adjuster drive assembly.

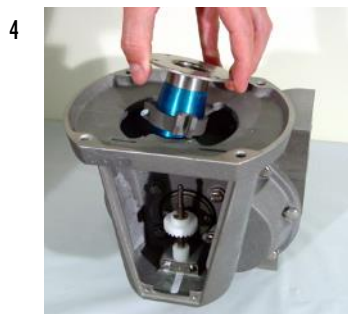

## Disassembly of Meter (Continued)



### ***!WARNING!***

All internal pressure must be relieved to ZERO (0) pressure before beginning disassembly of meter or components

### Draining Meter & Removing Counter Support

- 1) Drain the meter by turning it on either the inlet or outlet side.
- 2) Remove the counter bracket screws with a hex wrench or socket driver.
- 3) Remove the drain plugs on the front and rear covers using an allen wrench. Allow more fluid to drain from the meter.

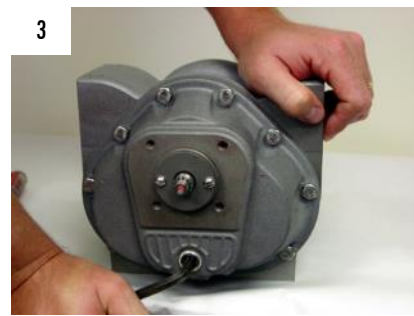

### Removing Packing Capsule

- 1) Remove the retaining plate using a standard flathead screwdriver.
- 2) Pull out the packing gland from the meter.

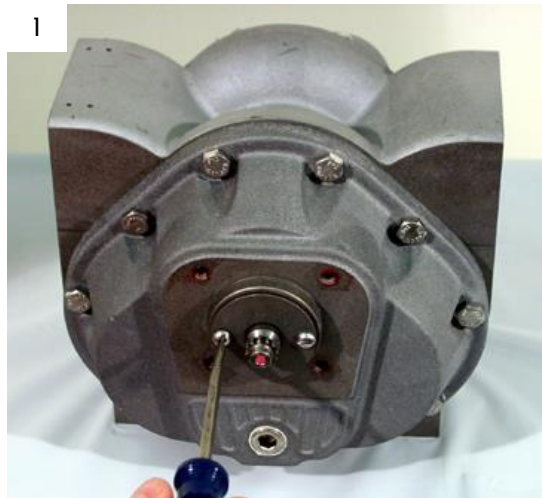

## Disassembly of Meter (Continued)



### Front & Rear Cover

- 1) Remove the screws on the front cover using a socket or box wrench.
- 2) Remove front cover.
- 3) Remove the screws on the back and remove rear cover.
- 4) Remove the O-ring from both sides of the housing

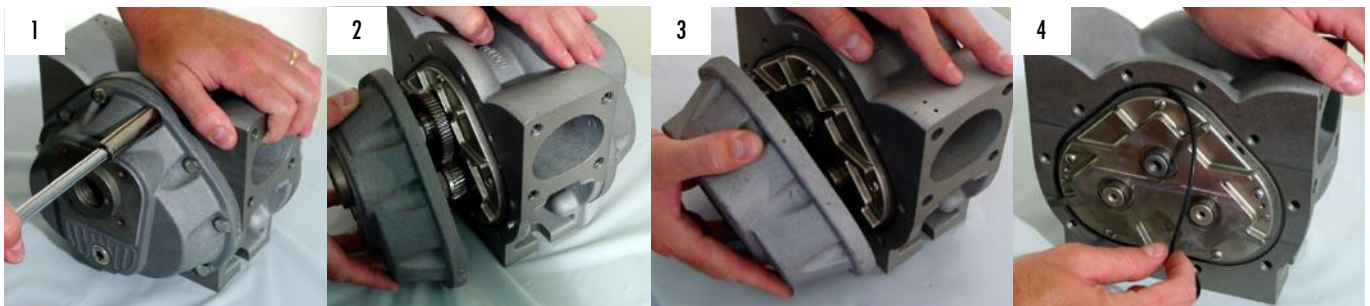

### Rotor Gears

- 1) Using a spare displacement rotor gear, place it between the rotor and blocking gear on the meter.
- 2) Use the socket or box wrench to loosen the right rotor gear lock nut. Repeat for the left rotor gear lock nut.
- 3) Move the spare displacement rotor gear to the other side and loosen the blocking rotor lock nut.

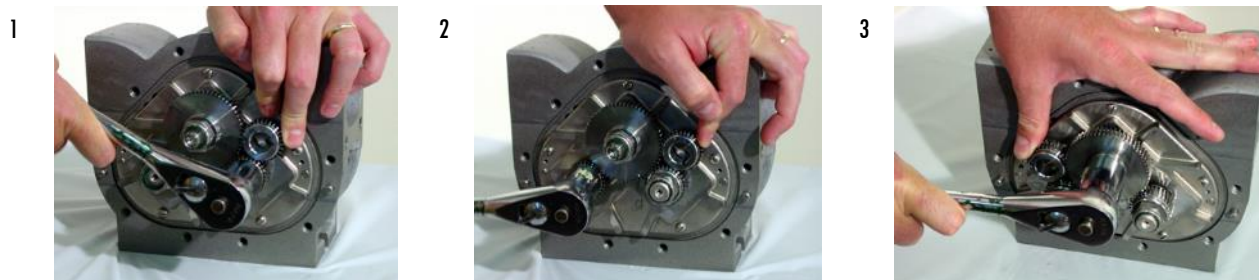

### Special Notes

- 1) DO NOT remove rotor gears using a screwdriver! This could damage the rotor gear and create potential wear problems within the measuring chamber.
- 2) If a spare rotor gear is not available, then use shop rag between gear teeth.



## Disassembly of Meter (Continued)



### Removing Bearing Plate

- 1) Remove the bearing plate retaining screws with a standard flathead screwdriver.
- 2) To remove bearing plate & rotors, insert a screwdriver into the notches near the dowel pins.
- 3) Gently pry the bearing plate off the dowel pins and slide out the bearing plate and rotors from the housing.

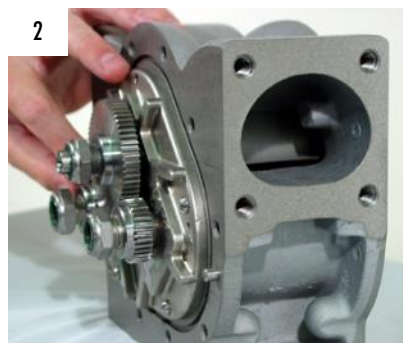
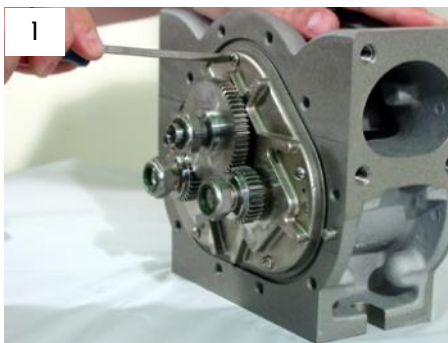

### Removing Lock Nuts & Rotors

- 4) Remove rotor lock nuts from each gear.
- 5) Pull gears off of rotor shaft.
- 6) Remove rotor key using pliers (this might not be necessary as rotor may slide right out of bearing plate).
- 7) Remove rotors from bearing plate.

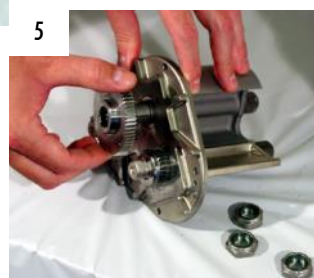
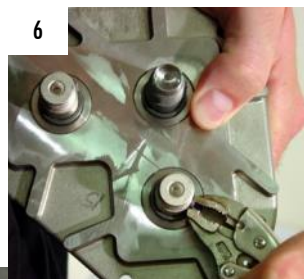

## Inspection of Parts

- 1) Inspect the surfaces of rotors, bearing plates, meter housing and gear teeth for any damage or wear.
- 2) Replace parts as needed.

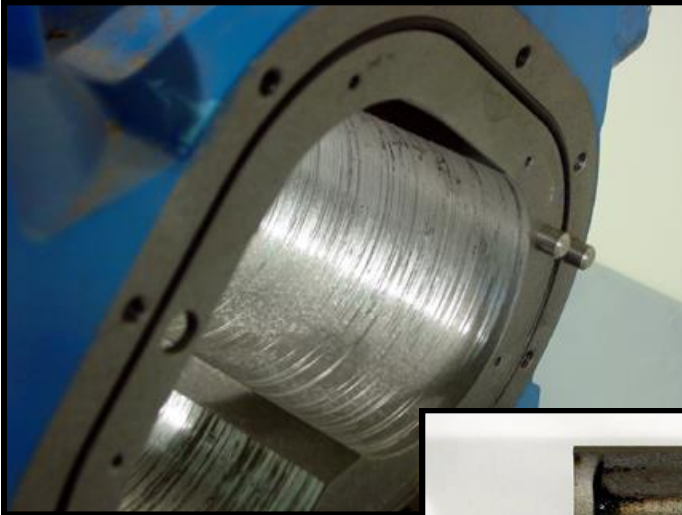

### CHAMBER WEAR

- A) Foreign debris, similar to sand or sludge, has run through the meter.
- B) Meter has been operated at a higher capacity and has worn the bearings out, allowing rotors to drop into the chamber.

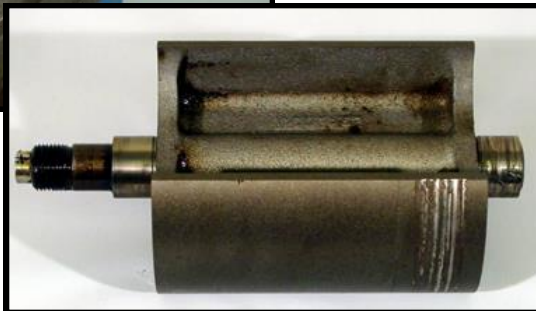

### GEAR WEAR

- A) Meter has been run on air.
- B) Meter has been operated at a higher volume capacity than what is rated.

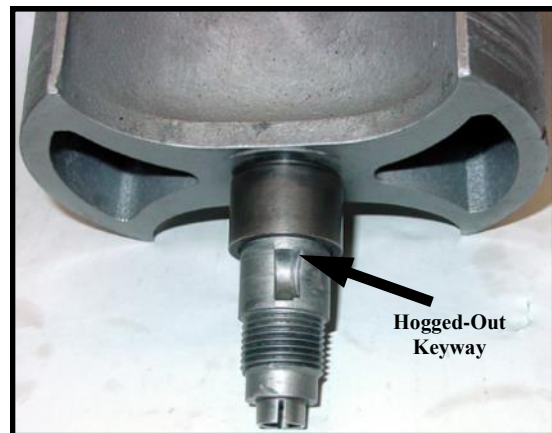
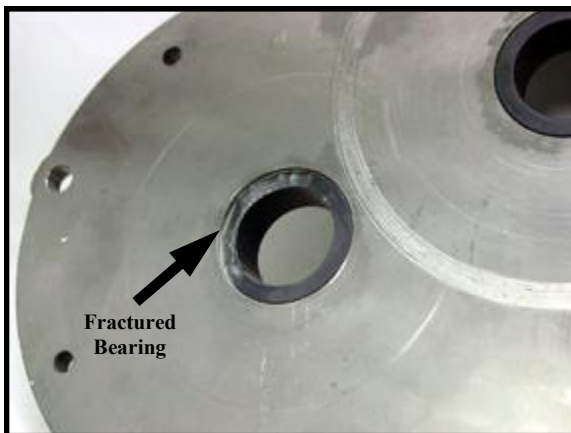

### HYDRAULIC SHOCK

- A) A valve downstream of the flow meter has abruptly shut off, creating hydraulic shock.
- B) Flow meter potentially had large volume of free air flowing within the system, followed by fluid.



## Reassembly of Meter

### Reinstalling Rotors

- 1) Install rear bearing plate on meter.
- 2) Insert threaded end of blocking rotor and the right displacement rotor into front gear plate (reinsert rotor keys if necessary).
- 3) Align the two rotors (see picture 3) before applying gears.



### Rotor Gear Timing

- 1) Slide on blocking rotor gear and position the 'arrow' that it is pointing toward the right displacement gear.
- 2) Align 'arrow' on displacement gear with the 'arrow' on the blocking gear and slide on right displacement gear.
- 3) Rotate the blocking rotor gear toward the left displacement gear and again align 'arrows' and slide on left displacement gear.
- 4) Gears and rotors should rotate freely if gears have been installed properly. If so, proceed with starting on the lock nuts until finger tight.

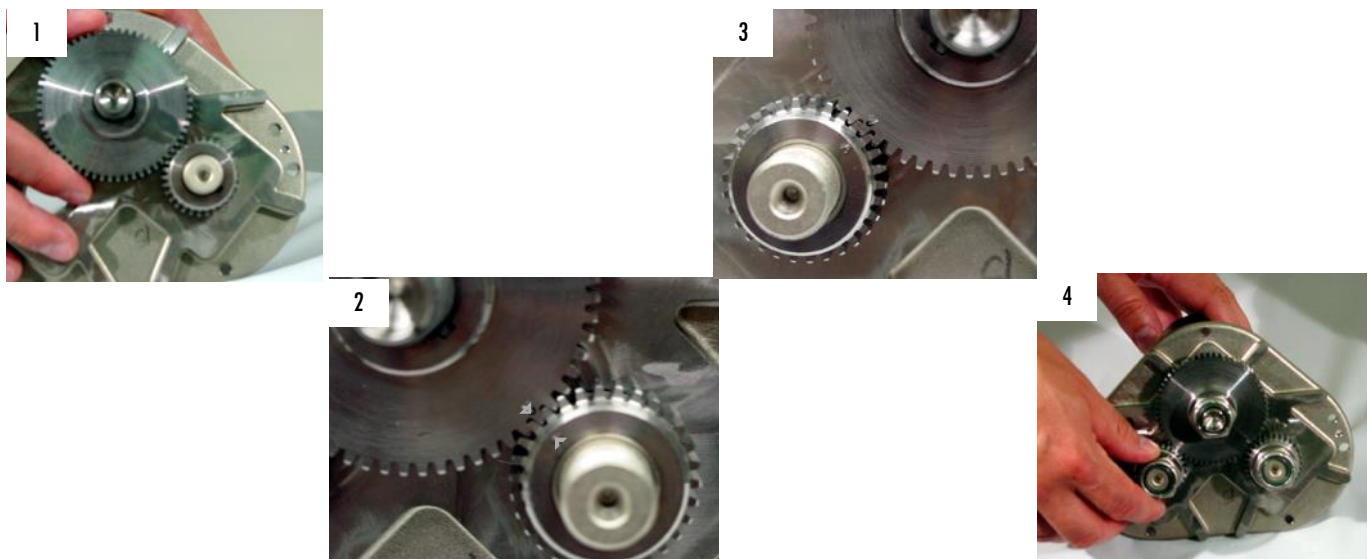

## Reassembly of Meter

### Reinstalling Bearing Plate

- 1) Align rotors on bearing plate (see picture) before inserting into meter.
- 2) Slide front bearing plate with rotors into meter housing and rear bearing plate.
- 3) Again, rotate gears to make sure they turn freely within the housing before proceeding.

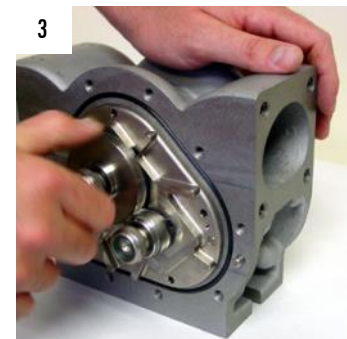
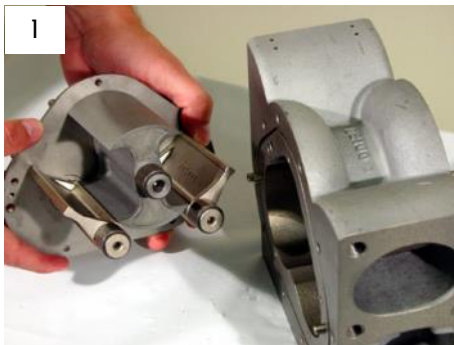

### Reinstalling Rotor Gears & Lock Nuts

- 1) Using the spare displacement gear (or shop rag), position between right displacement gear and blocking rotor gear.
- 2) Using the torque specifications, apply and tighten the lock nut on the right and left displacement gears.
- 3) Move the spare gear between the left displacement and blocking rotor gears and then tighten the lock nut on the blocking rotor gear.

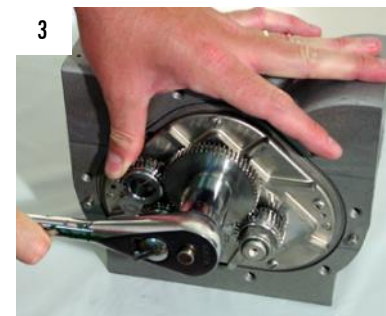
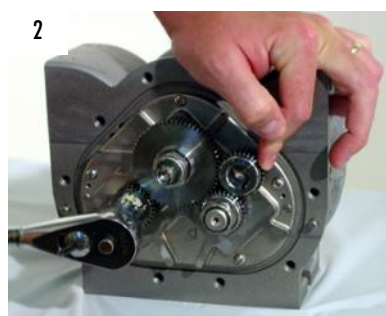
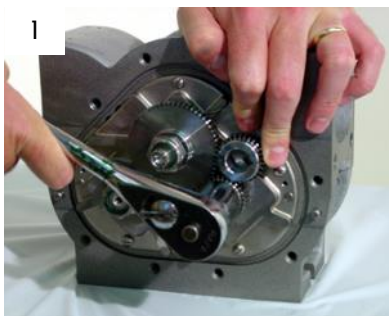

## Reassembly of Meter

### Reinstalling Packing Capsule & Front/Rear Covers

- 1) Reinstall cover O-rings on the front and rear of meter housing.
- 2) Reinsert packing capsule into front cover of meter with retaining plate and tighten screws.
- 3) When attaching front cover, align packing capsule blade with the slot on the blocking rotor sleeve. Tighten all front cover screws.
- 4) Attach rear cover and tighten all screws.

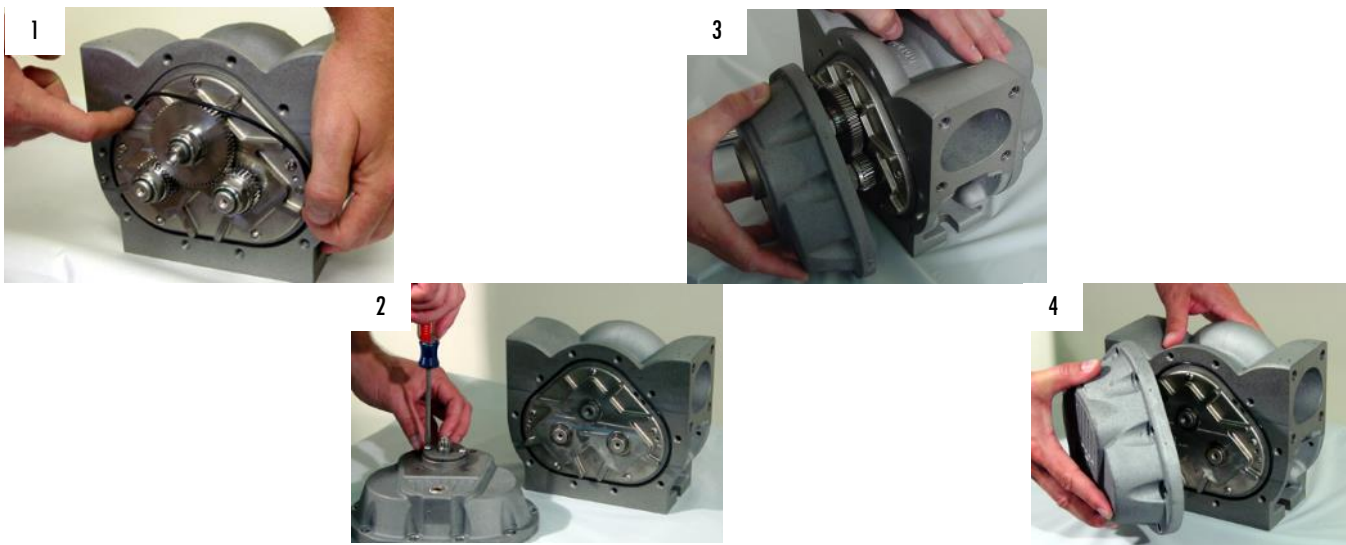

### Reinstalling Counter Support & Adjuster Drive Shaft

- 1) Position the counter support on the front side of meter and tighten all screws.
- 2) Reinsert adjuster drive shaft into the support housing. Assure that adjuster face gear teeth mesh completely with the packing capsule gear. The face gear and packing gear should mesh snugly, but do not overtighten as this will cause premature wear on the gears.
- 3) Slide down the adjuster mounting bracket and tighten the screws.

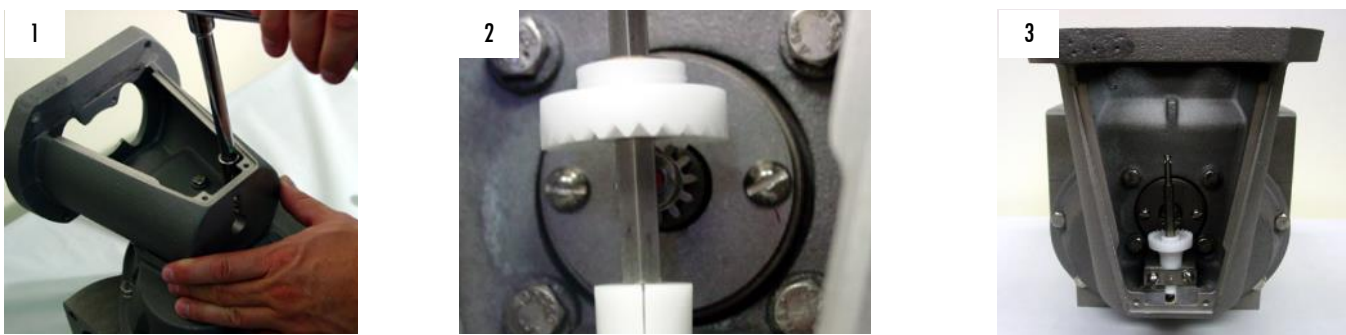

## Reassembly of Meter (Continued)

### Reinstalling Adjuster

- 1) Reinsert the adjuster into the top of the counter support and assuring that it mates with the drive shaft.
- 2) Tighten the screws that secure the adjuster plate to the counter support.



### Reinstalling Dust Cover

- 1) Reattach dust cover and tighten the screws.
- 2) Back where we started.

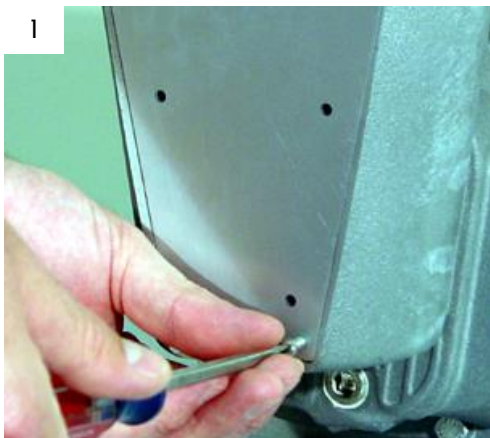

## Disassembly of 720 Strainer Assembly



### ***!WARNING!***

All internal pressure must be relieved to ZERO (0) pressure before beginning disassembly of meter or components

- 1) Using a hex or socket wrench, remove the four screws and washers from the cover plate.
- 2) Remove the cover plate and O-ring from the housing.
- 3) Remove the strainer screen.
- 4) Check inside housing for any debris and remove using a clean cloth.
- 5) Clean strainer screen by rinsing with a liquid cleaning agent compatible to your product application. A brush may be used to remove imbedded particles. If screen is too dirty to clean, then replace the screen.
- 6) Wipe clean the face of the cover plate and seal ring. Check O-rings for damage and replace as needed.

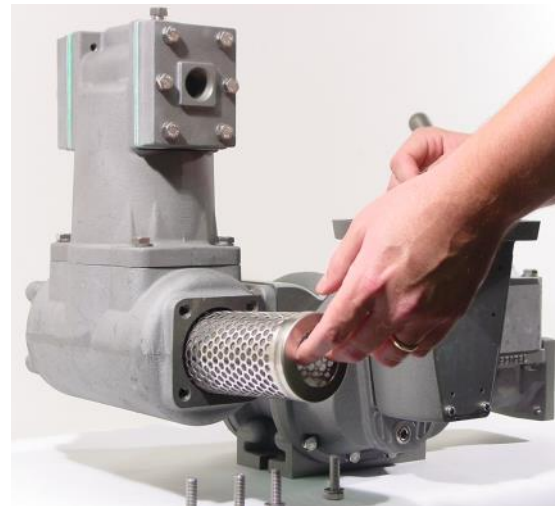
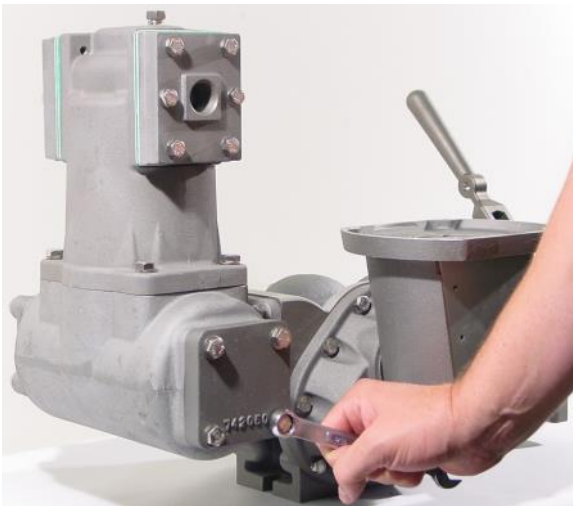

## Reassembly of 720 Strainer Assembly

- 1) Replace the strainer screen into the housing.
- 2) Place the end cover O-ring in the groove of the end cover.
- 3) Put the end cover with O-ring installed on the strainer housing. Replace and fasten end cover with the 4 screws and washers. Tighten the screws according to the torque chart.

## Disassembly of 730 Air Eliminator Assembly

### ***!WARNING!***

All internal pressure must be relieved to ZERO (0) pressure before beginning disassembly of meter or components

- 1) Using a 1/2" wrench or socket, remove the cover screws from air eliminator cover plate.
- 2) Remove cover plate.
- 3) Remove valve plate, inspect and replace as needed.

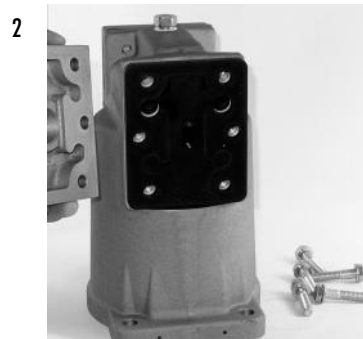
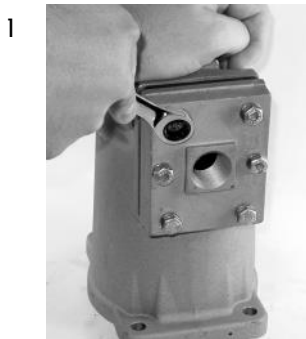

- 1) To remove the air eliminator assembly, remove the four screws and washers attaching it to the strainer assembly.
- 2) Using a flathead screwdriver, remove the screws attaching reed valves to air eliminator housing.
- 3) Remove the two screws on the diffuser screen.
- 4) Slide out diffuser shaft assembly.
- 5) Remove the two screws attaching reed valve to the float assembly. Inspect and replace reed valves as needed.

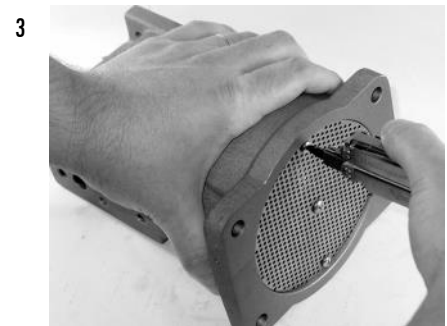
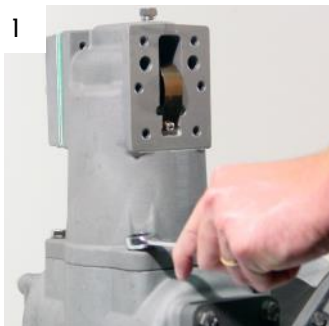

## Disassembly of 750-20 Hydraulic Valve



### ***!WARNING!***

All internal pressure must be relieved to ZERO (0) pressure before beginning disassembly of meter or components

- 1) Drain all fluid from metering system prior to valve removal.
- 2) Using a 9/16" hex or socket wrench, remove the four screws connecting the valve to the meter. Remove valve from meter and piping.
- 3) Place valve on flat surface and remove the four screws on the valve cover.
- 4) Pull the handle and spring assembly out of the valve housing.

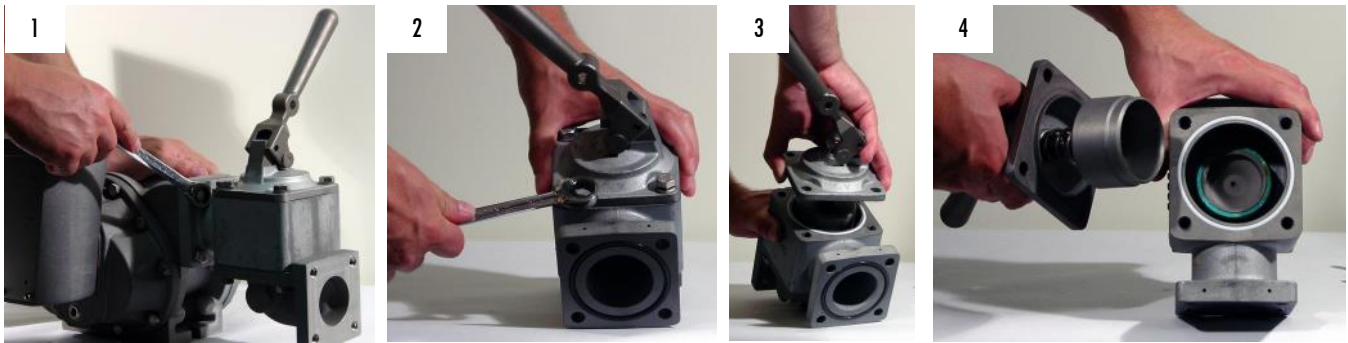

- 5) Using a socket wrench, remove the nut and washer from the valve shaft of piston assembly.
- 6) Remove piston housing.
- 7) Remove external piston spring and then the internal piston spring..
- 8) Inspect piston springs and seals, clean and replace as needed.

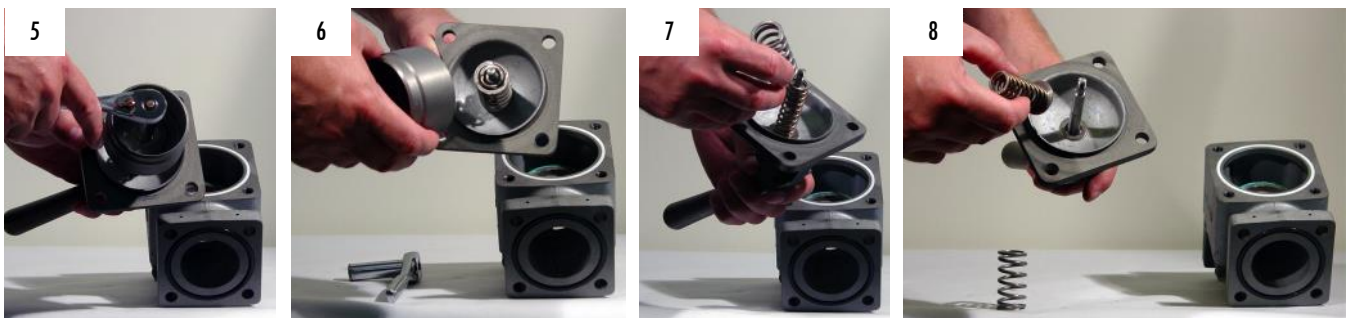

## Disassembly of 750-20 Hydraulic Valve



- 1) Using a 9/16" hex or socket wrench, remove the screws attaching the elbow to the valve body.
- 2) Remove the piston guide from the valve body.
- 3) Remove and inspect the upper and lower seals and replace as needed.
- 4) Using a flathead screwdriver, gently remove the valve body O-ring, inspect and replace if needed.

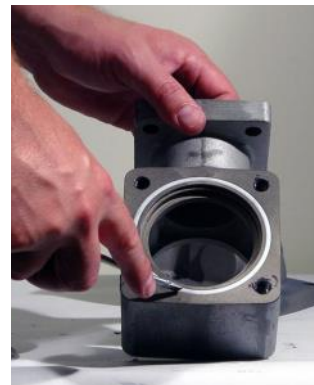

## Reassembly of 750-20 Valve

- 1) After seals have been cleaned or replaced, reinsert lower, upper and valve body seals into place.
- 2) Place the piston guide back into valve body.
- 3) Place the internal and external springs into the valve housing and reattach valve elbow to body.
- 4) Insert the piston guide assembly into valve housing.
- 5) Replace internal and external springs onto valve shaft and reattach the piston assembly with nut and washer.
- 6) Reinsert valve cover and piston assembly into valve body and press down to compress the springs.
- 7) While keeping pressure on the valve assembly, insert the four screws and washers into valve cover and tighten down.



## Disassembly of 760 Air Check Valve



### ***!WARNING!***

All internal pressure must be relieved to ZERO (0) pressure before beginning disassembly of meter or components

- 1) You may want to use a fixture or vice to compress and hold the poppet in place before loosening any screws.
- 2) Using a hex or socket wrench, loosen and remove the two screws and seal ring.
- 3) Slowly release the poppet from the housing until the spring exerts no more pressure.
- 4) Remove the poppet, and spring from the housing .
- 5) Check inside housing for any debris and remove using a clean cloth.
- 6) Inspect and replace poppet gasket if needed.

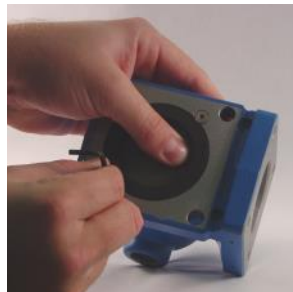

## Reassembly of 760 Air Check Valve

- 1) Replace poppet over the spring.
- 2) Compress poppet and spring into the valve housing.
- 3) With poppet and spring completely compressed, place the seal ring in housing.
- 4) Replace and fasten the two retaining ring screws.

## Meter Trouble Shooting



**PROBLEM:** Leaking packing gland and/or housing

Check to see whether any O-Rings have been damaged or cover bolts have not been tightened enough.

Two common causes of packing gland leakage are thermal expansion and hydraulic shock.

If two valves in a piping system (on either side of the meter) are closed, isolating the meter, and if the temperature rises as little as 1°F in the system, the possible rise in pressure due to temperature would exceed the working pressure rating of the meter. To avoid this hazard caused by thermal expansion, a pressure-relief valve must be installed in the system near the meter.

Hydraulic shock occurs when a large volume (mass) of liquid is moving through a pipe line at normal operating flow rate and a valve is suddenly closed. When the flow is so suddenly stopped, the entire mass of the liquid in the piping system acts as a battering ram, causing a shock effect within the meter. The greater the mass, length of line and/or velocity, the greater the hydraulic shock. Since the valve is usually located at the meter outlet, the meter housing, packing gland and the meter internal components receive the full impact of this hydraulic shock. To prevent this hazard, a slow closing two-stage valve should be used in conjunction with the metering system. On those systems where mass, length of line, etc. are of such magnitude as to preclude the elimination of hydraulic shock with the use of a two-stage slow closing valve, an impact-absorbing air cushioning device should be used.

**PROBLEM:** Product flows through meter but register does not operate.

- A) Gear train motion interrupted by non-functioning gear due to broken pin or key. Replace pin or key where required.
- B) If all meter parts are moving then problem is in register.
- C) Remove register from meter. If all meter parts are moving but output shaft of adjuster assembly is not, adjuster is worn and must be replaced.
- D) If totalizer numerals (small numbers) on register are recording, but the big numerals are not moving, register needs repair.

**PROBLEM:** Product flows through meter but register does not record correctly.

- A) Adjuster assembly not properly calibrated, See METER CALIBRATION on page 13 for more instructions.
- B) The factory installed gear train may have incorrect gearing ratio.
- C) Check register for defects.

**PROBLEM:** No flow through meter.

- A) Faulty non-functioning pump.
- B) Foreign matter within the system, meter or components.
- C) Meter has a broken rotor or rotor shaft.
- D) Excessive wear on timing gears or bearings.
- E) Meter “frozen” due to build-up of chemical “salts” inside metering chamber, sufficient to stop rotation of rotors.
- F) Valve not open or not functioning.

**PROBLEM:** Meter runs too slow.

- A) There is a flow restriction within the system (tees, elbows, valves, etc.)
- B) Foreign matter in system, meter or components.
- C) Product viscosity is different or has changed from what was originally known.
- D) Meter gears or rotors partially “salted” enough to slow up rotation of parts.
- E) Valve internal mechanism faulty. Valve does not open fully or the linkage is not properly adjusted.

## Air Eliminator Trouble Shooting



**PROBLEM:** Product is flowing from the Air Eliminators vents

- A) Foreign matter located in between seal plate O-rings and metal reeds.
- B) The seal plate O-ring may be worn through service life.
- C) The seal plate O-ring may be cut or dislodged and requires replacement.
- D) The float may have been punctured, containing liquid, not allowing the float to rise and seal the air vents.
- E) The float may have been ruptured from a surge of pressure within the system.
- F) The metal reeds may be fatigued and requires replacement.
- G) The metal reeds may be out of alignment with the seal plate.

**PROBLEM:** The meter is still registering air within the system

- A) The air return line is not the required minimum of 1/2" ID.
- B) The metering system has insufficient means of eliminating air to the atmosphere. Some examples:  
An incorrectly installed "Catch Can" reservoir is located lower than the air eliminator itself. The reservoir is allowed to become full or the vent is improperly sized.

There can be numerous reasons why the meter may still register air. First look at the system configuration and see where air is being introduced into the system. Then determine if the meter is registering "free air" or "entrained air". Free Air is much easier to remove from the metering system and may require the use of a Spring Loaded Back Check Valve and/or a Differential Air Check Valve and/or a High Volume Strainer to help the air eliminator operate more effectively.

Entrained Air is much more difficult to remove. Typically the best way to eliminate Entrained Air will be to remove the source of entry of air into the system. Some typical examples would be a cavitating pump or a leaking pump or faulty valve seals. A High Volume Strainer may help accumulate the liquid long enough to disperse the Entrained Air from the system. See Air Elimination in the Service Manual for more information.

## Preset Valve Trouble Shooting



**PROBLEM:** The valve will not close completely.

- A) The shaft of the piston may be bent from excessive force.
- B) Debris may be located between the piston and piston guide.
- C) The upper or lower seals may be worn, swollen from incompatibility or cut from debris.
- D) The mechanical linkage to the Veeder-Root 7889 preset counter may be tight. The linkage must be loose for the preset to operate correctly.
- E) The Veeder-Root preset may have a worn or bent trip mechanism that is not allowing the preset to function.

**PROBLEM:** The valve shuts immediately upon first stage trip, bypassing the second stage closure.

- A) The mechanical linkage might need to be adjusted, moving the Nylon locking nuts forward or backwards to change the closing of the preset valve.
- B) The Veeder-Root preset may need to be “raked” or adjusted for the correct shut-off volume. See Veeder-Root 7889 preset service manual for further instructions.
- C) The Veeder-Root preset may have a worn or bent trip mechanism that is not allowing the preset to function.

**PROBLEM:** The preset batch over or under registers correct volume.

- A) The mechanical linkage might need to be adjusted, moving the Nylon locking nuts forward or backwards to change the closing of the preset valve.
- B) The Veeder-Root preset may need to be “raked” or adjusted for the correct shut-off volume. See Veeder-Root 7889 preset service manual for further instructions.
- C) The Veeder-Root preset may have a worn or bent trip mechanism that is not allowing the preset to function.

## 760 Air Check Valve Trouble Shooting



**PROBLEM:** Product will not be pumped through the meter.

Pressure has increased behind the air check piston and will not open the valve. One of the valve plates on the air eliminator outlet must be installed so that the round tab is located to the top of the device. This allows the minimum bleed function on the valve plate to work properly. Ensure that the air check side outlet is connected to the air eliminator outlet cove where the plate with the round tab is toward the top. This will allow for the proper release of pressure from the air check.

# Material Safety Data Sheet

24 HOUR EMERGENCY ASSISTANCE  
(260) 833-3173GENERAL MSDS ASSISTANCE  
(260) 484-0301

CODE: RPS

HAZARD RATING&gt; LEAST-0 SLIGHT-1 MODERATE-2 HIGH-3 EXTREME-4

DR LUBRICANTS, INC.  
4611 NEWAYGO ROAD, SUITE D  
FORT WAYNE, IN 46808

DATE: 01/21/06

TELEPHONE NUMBER: (260 484-0301)

## SECTION I - PRODUCT IDENTIFICATION

PRODUCT: **RP 1060**

## SECTION II - COMPOSITION AND HAZARDOUS INFORMATION\*

CHEMICAL NAME	CAS NUMBER	WT. PERCENT IS LESS THAN	OCCUPATIONAL EXPOSURE LIMITS (TLV-TWA) (TLV-STEL)
PETROLEUM HYDROCARBON	64741-65-7	45.0	100MG/M3
PETROLEUM HYDROCARBON	64742-53-6	65.0	5MG/M3

\*ITEMS NOT SHOWN ARE NOT LISTED IN THE OSHA - T.S.C.A. HAZARDOUS CHEMICALS LISTING.

## SECTION III - PHYSICAL DATA

BOILING RANGE:	NA	VAPOR DENSITY:	NA
ODOR:	PETROLEUM ODOR	EVAPORATION RATE:	NA
APPEARANCE	AMBER LIQUID	SOLUBILITY:	INSOLUBLE
VOLATILE BY WEIGHT:	NA	PRODUCT DENSITY:	0.829
VOLATILE BY VOLUME:	NA		

## SECTION IV - FIRE AND EXPLOSION HAZARD DATA

FLAMMABILITY CLASSIFICATION: COMBUSTIBLE      FLASH POINT: 170 F      LEL: NA  
(CLEVELAND OPEN CUP)      UEL: NA

DOT: COMBUSTIBLE LIQUID

EXTINGUISHING MEDIA: CARBON DIOXIDE, DRY CHEMICAL, FOAM

## Material Safety Data Sheet (Continued)

PRODUCT: RP 1060

PAGE - 2

---

---

### SECTION IV - FIRE AND EXPLOSION HAZARD DATA

---

---

UNUSUAL FIRE AND EXPLOSION HAZARDS : DO NOT DIRECT A SOLID STREAM OF WATER ONTO BURNING PRODUCT. THIS MAY CAUSE SPREADING AND INCREASE THE FIRES INTENSITY. COMBUSTION MAY PRODUCE: OXIDES OF CARBON, AND INCOMPLETELY BURNED HYDROCARBONS IN THE FORM OF FUMES AND SMOKE.

SPECIAL FIREFIGHTING PROCEDURES: WEAR A SELF-CONTAINED BREATHING APPARATUS WITH FULL FACEPIECE.

---

---

### SECTION V - HEALTH HAZARD DATA

---

---

EFFECTS OF OVER EXPOSURE: MAY CAUSE MILD EYE IRRITATION AND REDNESS. PROLONGED OR REPEATED EXPOSURE TO THE SKIN MAY RESULT IN LOSS OF NATURAL OILS ACCOMPANIED BY DRYNESS, CRACKING AND DERMATITIS. INGESTION MAY RESULT IN NAUSEA, DIARRHEA AND GASTRO INTESTINAL IRRITATION. OVEREXPOSURE TO MIST MAY CAUSE UPPER RESPIRATORY TRACT IRRITATION AND DIFFICULTY BREATHING.

MEDICAL CONDITIONS PRONE TO AGGRAVATION BY EXPOSURE: NONE KNOWN.

PRIMARY ROUTE(S) OF ENTRY: DERMAL INHALATION INGESTION.

EMERGENCY AND FIRST AID PROCEDURES: IN CASE OF EYE CONTACT, IMMEDIATELY FLUSH EYES WITH CLEAN WATER FOR AT LEAST 15 MINUTES. IF EYE IRRITATION PERSISTS, CONTACT A PHYSICIAN. IN CASE OF SKIN CONTACT, REMOVE ANY CONTAMINATED CLOTHING AND RINSE SKIN THOROUGHLY WITH WATER FOR AT LEAST 15 MINUTES. IF SKIN IRRITATION PERSISTS, CONTACT A PHYSICIAN. IN CASE OF OVEREXPOSURE TO MIST, REMOVE VICTIM TO FRESH AIR: IF BREATHING IS DIFFICULT ADMINISTER OXYGEN: AND CONTACT A PHYSICIAN IMMEDIATELY. IF PRODUCT IS INGESTED DO NOT INDUCE VOMITING: CONTACT A PHYSICIAN.

---

---

### SECTION VI - REACTIVITY DATA

---

---

STABILITY: THIS PRODUCT IS STABLE UNDER NORMAL STORAGE CONDITIONS.

HAZARDOUS POLYMERIZATION: WILL NOT OCCUR UNDER NORMAL CONDITIONS.

HAZARDOUS DECOMPOSITION PRODUCTS: THERMAL DECOMPOSITION MAY RESULT IN THE FORMATION OF: OXIDES OF CARBON, AND INCOMPLETELY BURNED HYDROCARBONS IN THE FORM OF FUMES AND SMOKE.

CONDITIONS TO AVOID: AVOID CONTACT WITH OPEN FLAME, STORE IN ROOM TEMPERATURE AREA.

INCOMPATIBILITY: AVOID CONTACT WITH STRONG OXIDIZING AND REDUCING AGENTS AND STRONG ALKLI.

## Material Safety Data Sheet (Continued)

PRODUCT: RP 1060

PAGE - 3

---

---

### SECTION VII - SPILL OR LEAK PROCEDURES

---

---

STEPS TO BE TAKEN IN CASE MATERIAL IS RELEASED OR SPILLED: FOR SMALL SPILLS: SOAK UP SPILL WITH ABSORBENT MATERIAL. FOR LARGE SPILLS: DIKE SPILL AND PUMP INTO DRUMS FOR PROPER DISPOSAL.

WASTE DISPOSAL METHOD: DISPOSE OF IN ACCORDANCE WITH ALL LOCAL STATE AND FEDERAL REGULATIONS.

---

---

### SECTION VIII - SAFE HANDLING AND USE INFORMATION

---

---

RESPIRATORY PROTECTION: NORMALLY NOT REQUIRED, HOWEVER, WHEN THE TLV IS EXCEEDED WEAR THE APPROPRIATE MSHA/NIOSH APPROVED RESPIRATOR.

VENTILATION: PROVIDE ADEQUATE VENTILATION (SUCH AS MECHANICAL OR LOCAL) TO ASSURE TLV IS NOT EXCEEDED.

PROTECTIVE GLOVES: NORMALLY NOT REQUIRED, HOWEVER, IF HANDS ARE FREQUENTLY IN FLUID WEAR OIL AND CHEMICAL IMPERVIOUS GLOVES.

EYE PROTECTION: SAFETY GLASSES REQUIRED FOR NORMAL USAGE, WEAR CHEMICAL GOGGLES WHEN EXCESSIVE SPLASHING MAY OCCUR.

OTHER PROTECTIVE EQUIPMENT: NORMALLY NOT REQUIRED, HOWEVER, WHERE REPEATED CONTACT OCCURS, WEAR IMPERVIOUS CLOTHING AND BOOTS.

HYGIENIC PRACTICES: FOLLOW STANDARD INDUSTRIAL HYGIENE PRACTICES. LAUNDER ANY CONTAMINATED CLOTHING BEFORE RE-USE.

---

---

### SECTION IX - SPECIAL PRECAUTIONS

---

---

PRECAUTIONS TO BE TAKEN IN HANDLING AND STORAGE: DO NOT STORE IN THE PRESENCE OF HEAT, SPARKS, FLAME OR ANY OTHER SOURCES OF IGNITION. STORE AWAY FROM STRONG OXIDIZING AGENTS. EMPTY DRUMS MAY CONTAIN PRODUCT RESIDUES. ALL SAFETY PRECAUTIONS TAKEN WHEN HANDLING THIS PRODUCT SHOULD ALSO BE TAKEN WHEN HANDLING EMPTY DRUMS AND CONTAINERS.

OTHER PRECAUTIONS: NONE

## Material Safety Data Sheet (Continued)

PRODUCT: RP 1060  
PAGE - 4

---

---

### SECTION X - HMIS/NFPA RATINGS

---

---

HMIS:HEALTH:1 FLAMMABILITY:2 REACTIVITY:0 PERSONAL PROTECTION:C  
NFPA:HEALTH:1 FLAMMABILITY:2 REACTIVITY:0 SPECIFIC HAZARD:

---

---

### SECTION XI - OTHER REGULATORY INFORMATION

---

---

LAND (TDG)

PROPER SHIPPING NAME: PETROLEUM DISTILLATES, N.O.S.  
HAZARD CLASS & DIVISION: 3  
UN NUMBER: 1268  
PACKING GROUP: III

---

---

THE INFORMATION CONTAINED HEREIN IS, TO THE BEST OF OUR KNOWLEDGE AND BELIEF, ACCURATE. HOWEVER, SINCE THE CONDITIONS OF HANDLING AND USE ARE BEYOND OUR CONTROL, WE MAKE NO GUARANTEE OF RESULTS, AND ASSUME NO LIABILITY FOR DAMAGES INCURRED BY USE OF THIS MATERIAL. IT IS THE RESPONSIBILITY OF THE USER TO COMPLY WITH ALL APPLICABLE FEDERAL, STATE AND LOCAL LAWS AND REGULATIONS.

---

---



## Notes

## Notes

## Warranty Information

New 700 rotary meters, equipment or components manufactured by Total Control Systems, a division of Murray Equipment, Inc. (TCS) with which this warranty is enclosed, are warranted by TCS to the original purchaser only for a period of TWELVE (12) months from installation or eighteen (18) months from the date of shipment, to be free, under normal use and service, from defects in material and workmanship.

Defects occurring within the stated warranty period, TCS will repair or replace, at TCS's option; provided that part or parts are returned to TCS transportation charges prepaid, and TCS's examination discloses the parts or workmanship to have been defective upon delivery to the purchaser.

**EXCLUSIONS:** Warranty does not cover any parts and equipment not manufactured by TCS, but these items may be covered by separate warranties of their respective manufacturers. This warranty does not extend to any equipment that has been subjected to misuse, negligence or accident or if operated in any manner other than in accordance with TCS's operating instructions and specifications.

**CLAIM PROCEDURES:** In order to obtain performance by TCS of its obligations under this warranty, the original purchaser must obtain a Return Goods Authorization (RGA) number from TCS's customer service department within 30 days of discovery of a purported breach of warranty, but not later than the expiration of the warranty period. Once authorization is received, return the RGA and defective meter, piece of equipment, or component covered by this warranty, with transportation charges prepaid, to TCS together with a written RGA form, MSDS sheet and packaging clearly marked with the RGA number. All RGA procedures must strictly be followed for safety and quick resolve. TCS reserves the right of refusal for shipments sent back freight collect and/or without proper paperwork.

**LIMITATIONS:** There are no other warranties of any kind, expressed or implied. TCS specifically disclaims any warranty of merchantability or of fitness for any particular purpose. TCS will determine if all parts or meter defect falls within the warranty guidelines and will repair or replace within a reasonable time span. TCS is not responsible for any in or out bound freight. TCS's sole obligation shall represent the buyer's sole and exclusive remedy shall be to repair or at TCS's option to replace any product or part determined to be defective. In no event shall TCS be liable for any special, direct, indirect, incident, consequential or other damages of similar nature, including without limitation, loss of profits, products, production time, or loss of expenses of any nature incurred by the buyer or any third party. TCS has not authorized on its behalf any representation or warranties to be made, nor any liability to be assumed except as expressly provided herein; there is no other express or implied warranty.

**REPAIR WARRANTY:** All repair work is warranted for ninety (90) days from the date of shipment to customer. Some parts may be warranted for longer periods by the Original Equipment Manufacturer.

**DESIGN AND EQUIPMENT CHANGES:** Any changes in design or improvements added shall not create any obligation to install same on equipment previously sold or ordered.

TOTAL CONTROL SYSTEMS  
2515 Charleston Place • Fort Wayne, Indiana 46808 U.S.A.  
Tel: (260) 484-0382 • Toll Free: (800) 348-4753 • Fax: (260) 484-9230  
sales@tcsmeters.com • www.tcsmeters.com

Check us out at [www.TCSmeters.com](http://www.TCSmeters.com)!



The Standard of Measurement

2515 Charleston Place  
Fort Wayne, IN 46808

Toll Free: (800) 348-4753  
Phone: (260) 484-0382  
Fax: (260) 484-9230  
Email: [sales@tcsimeters.com](mailto:sales@tcsimeters.com)

Check us out at [www.TCSimeters.com](http://www.TCSimeters.com)!